

Fluid Mechanics Community Meeting, TU WIEN, September 30th 2004

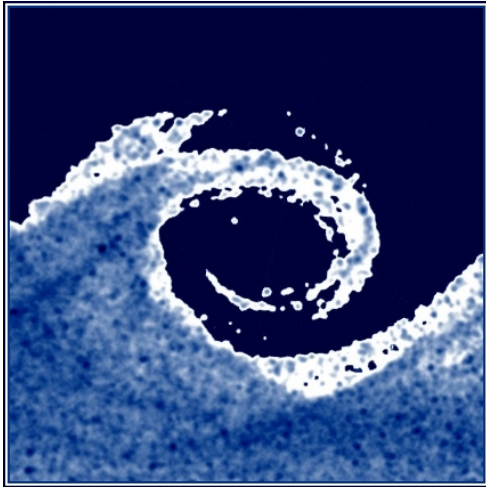

**CFD related
Research & Development
at the**

DEPARTMENT of FLUID MECHANICS

**Budapest University of Technology and Economics
HUNGARY**

**Prof. Tamás LAJOS
Dr. Gergely KRISTÓF
Dr. János VAD**

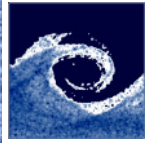

Radial pump simulation: comparison of simulated flow field and PIV data

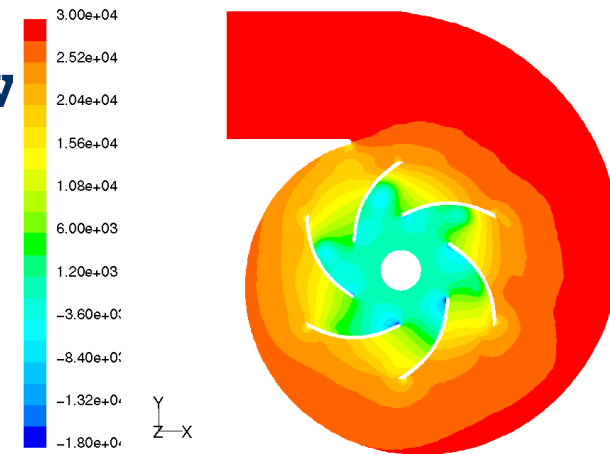

Contours of Static Pressure (pascal) (Time=1.5000e-01)
FLUENT 6.0 (3d, segregated, mgke, unsteady) Sep 13, 2002

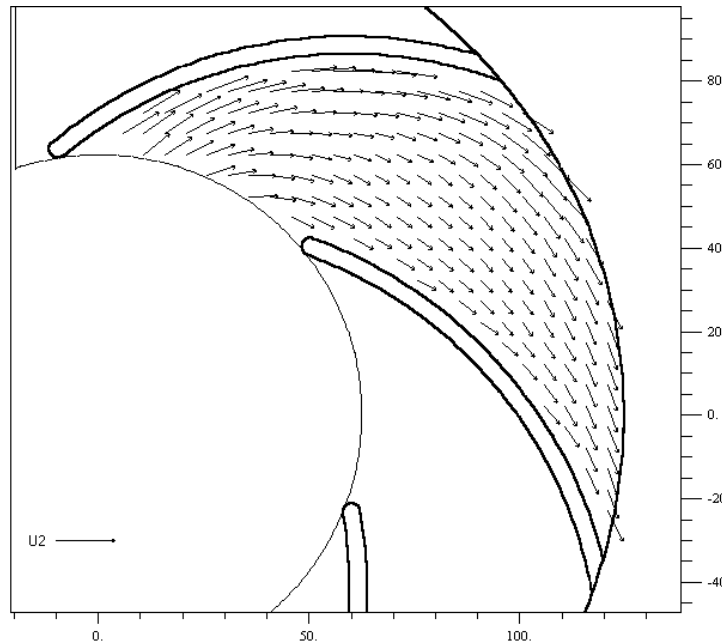

PIV measurement

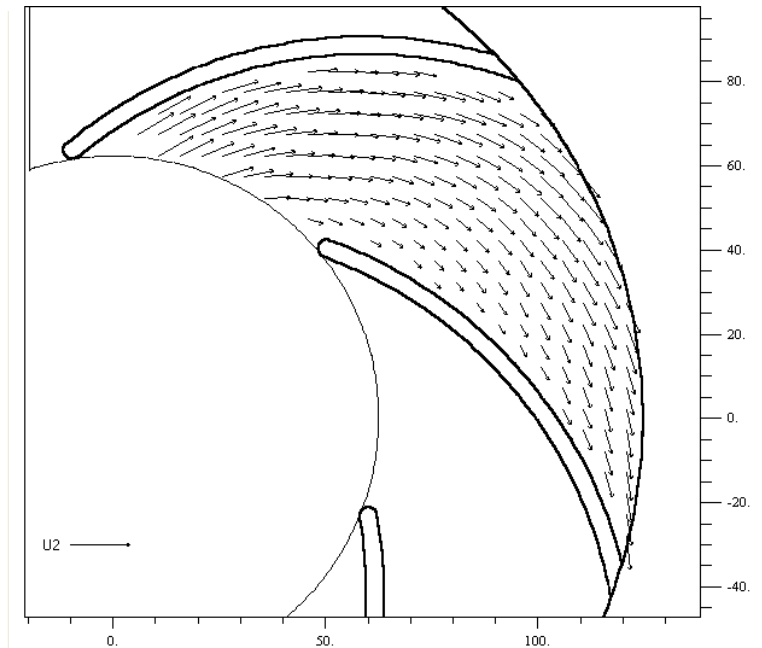

FLUENT simulation

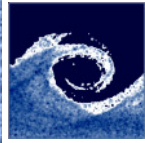

Optimization of side-channel fuel pump of cars

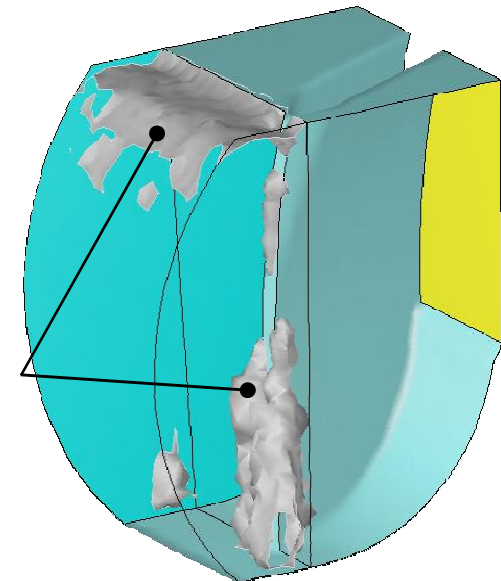
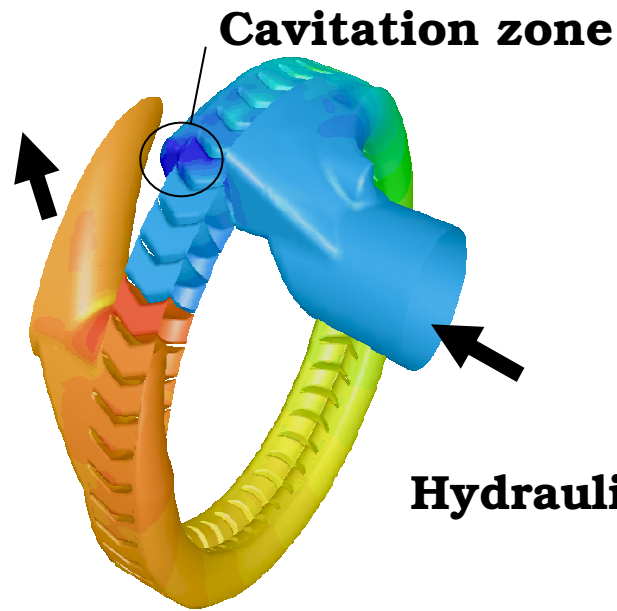
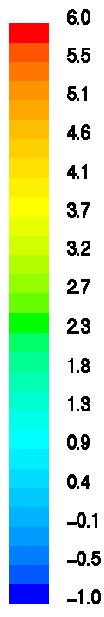
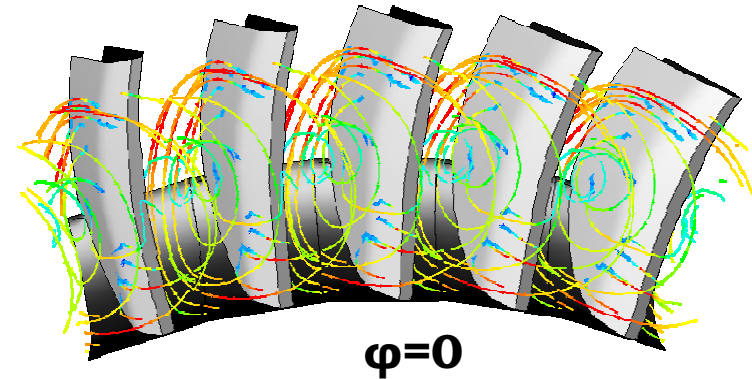
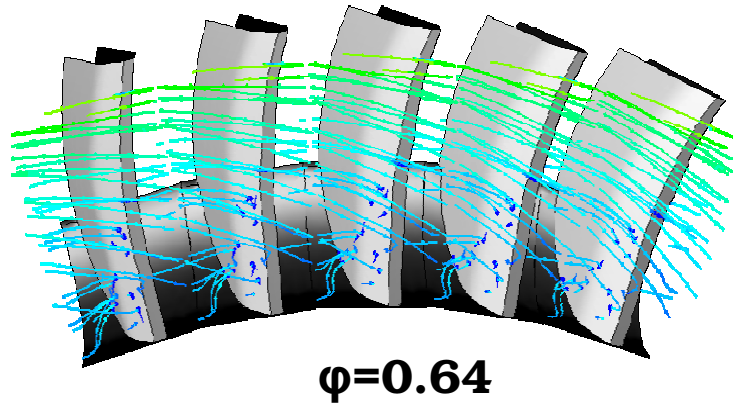

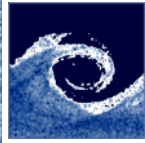

Simulation of exhaust system: nonuniform load of catalytic converter

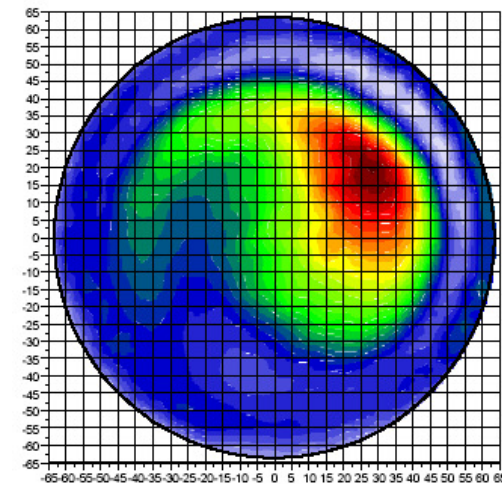
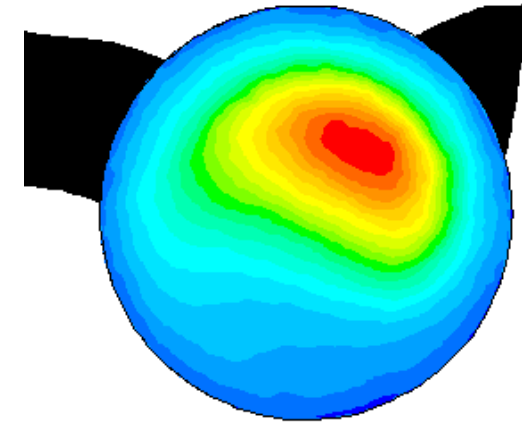
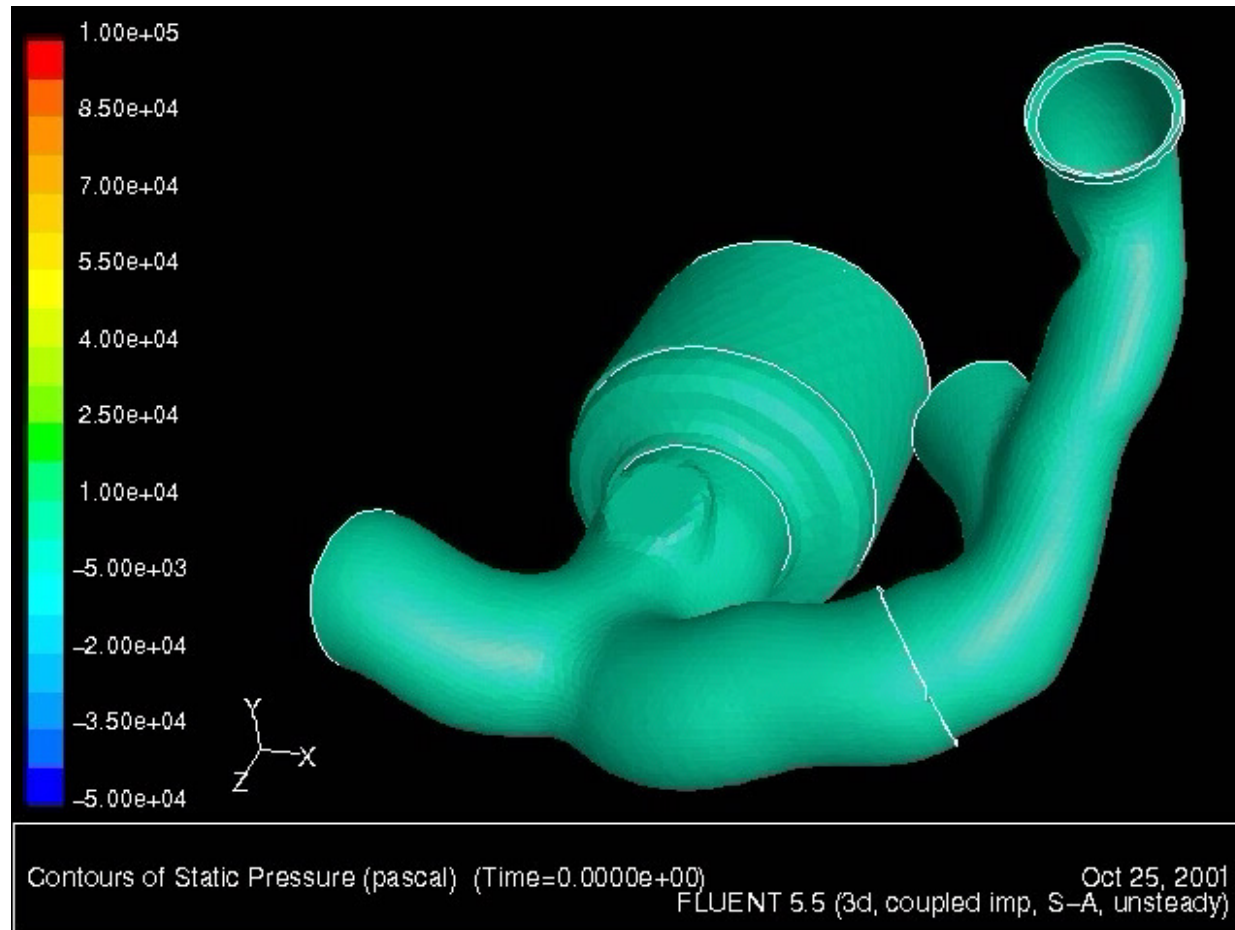

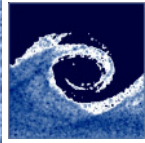

Vehicle Aerodynamics

Flow topology and validation on isolated wheel

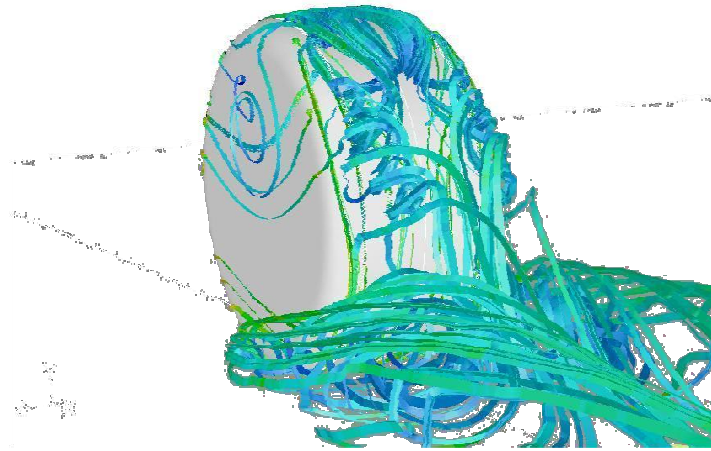

Flow topology in wheelhouse, interaction of flow inside wheelhouse and vehicle body

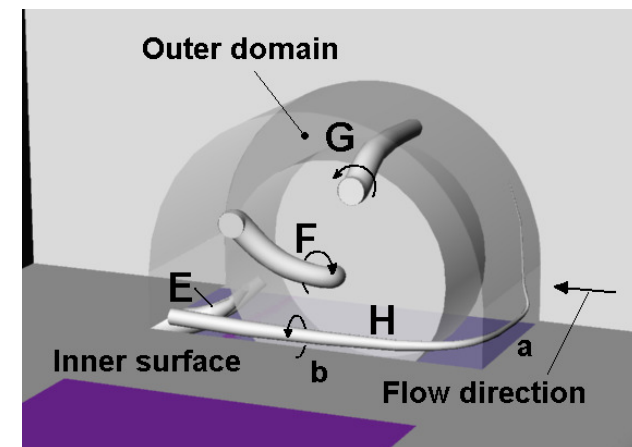
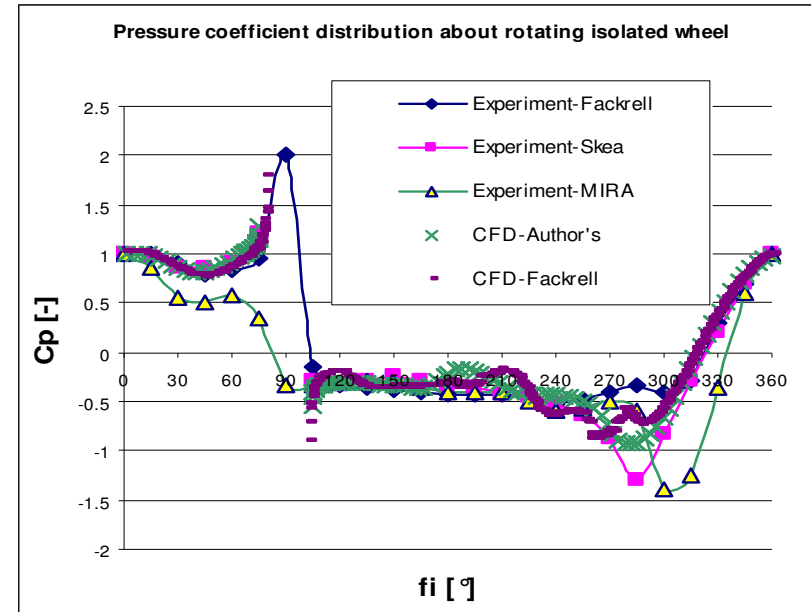
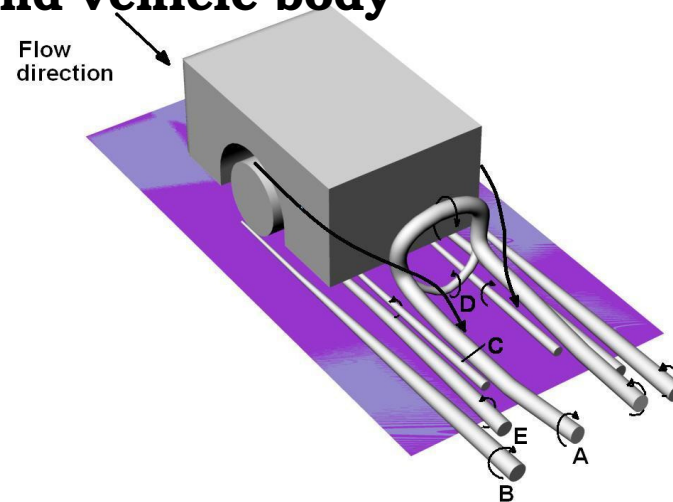

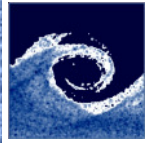

Measurement and numerical simulation of pollutant dispersion in urban atmosphere

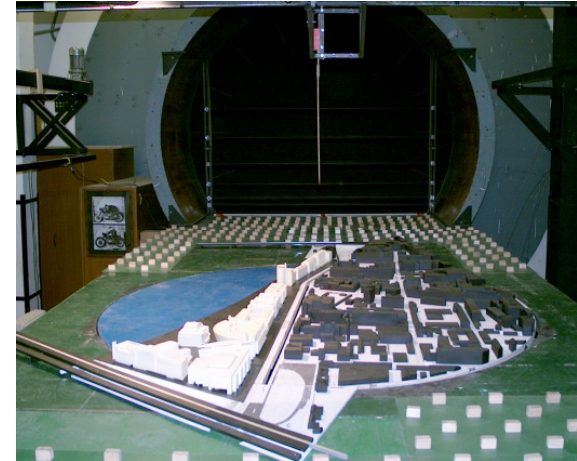
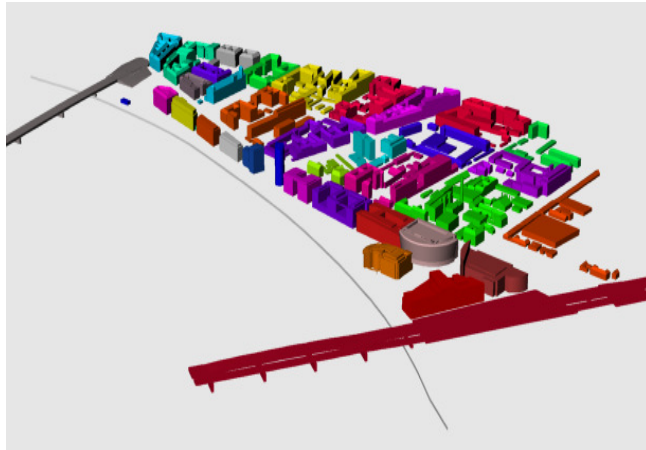

Numerical and wind tunnel model of Millennium City Center

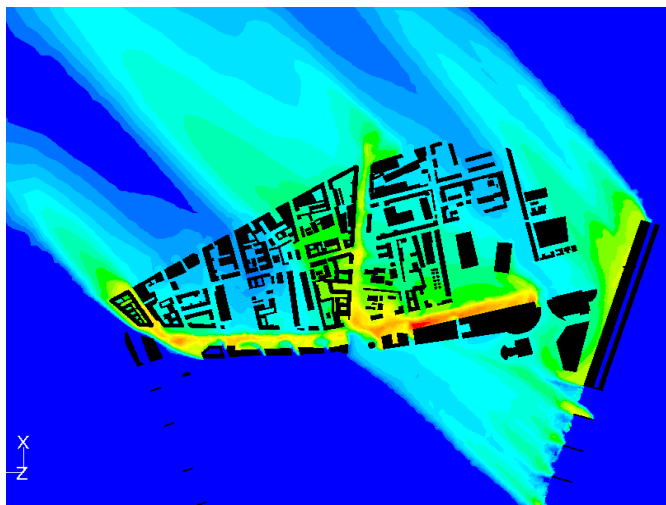

Pollutant concentration

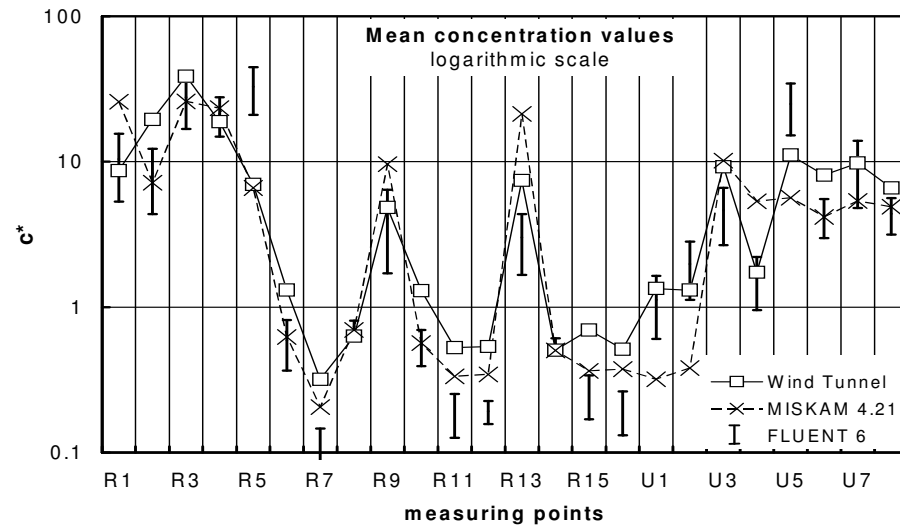

Comparison of simulation and measurement

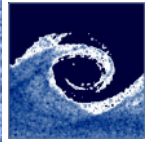

Numerical simulation and wind tunnel measurement of wind forces

Budapest Arena

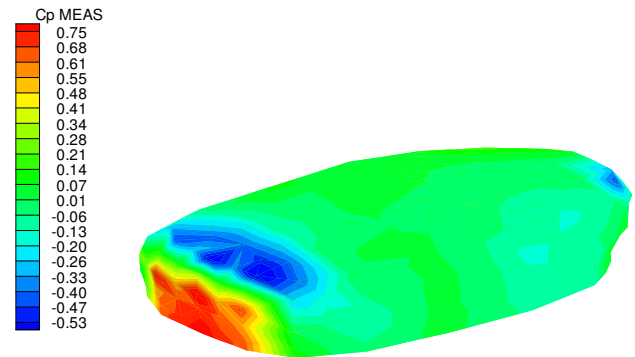

Measured in wind-tunnel

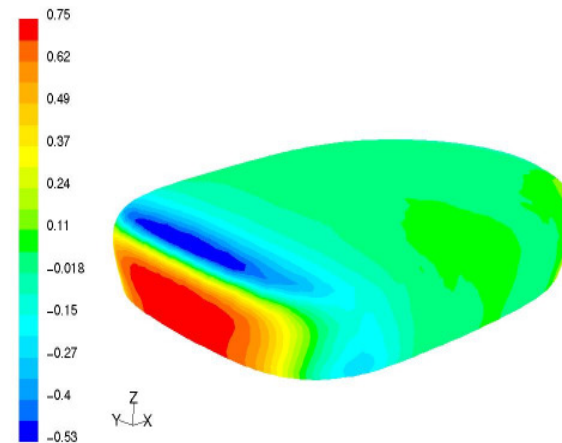

FLUENT 5.5

Ice-stadium Essen



Bild 6. Druckbeiwerte an äusserer Oberfläche (Cp [-])
Windrichtung 0° 1:300



Contours of Pressure Coefficient

May 21, 2002
FLUENT 6.0 (3d, segregated, rke)

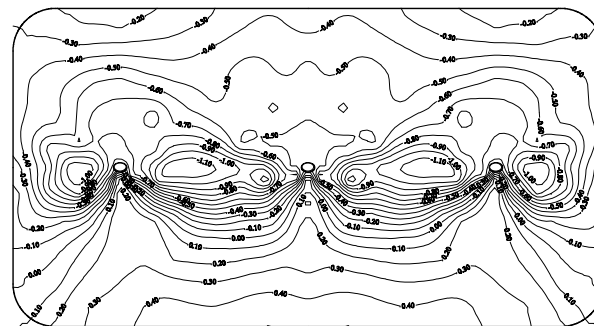
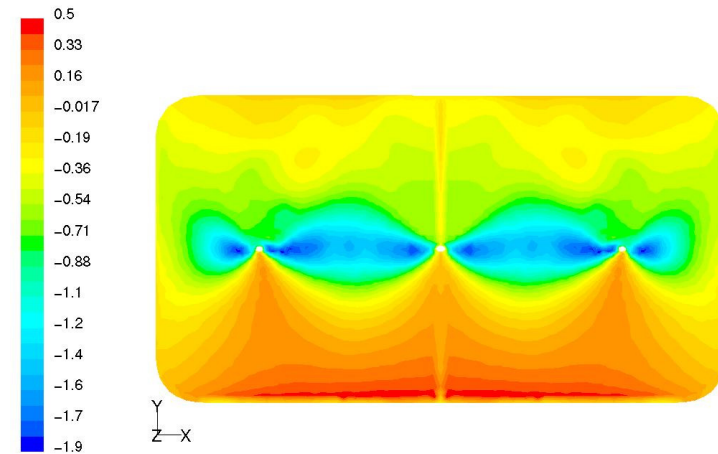
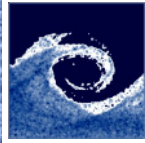

Air-conditioning & ventilation of large halls



Streamlines and temperature in a concert hall

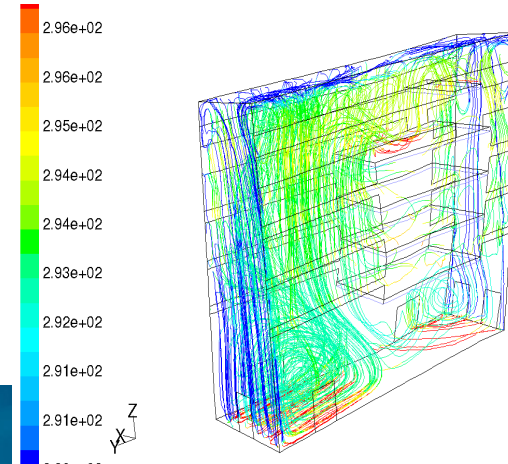

Flow in aula of a bank

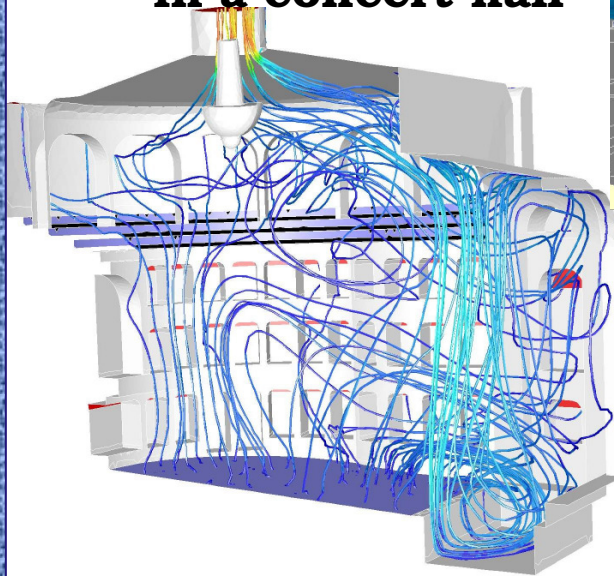

Streamlines in Opera-house

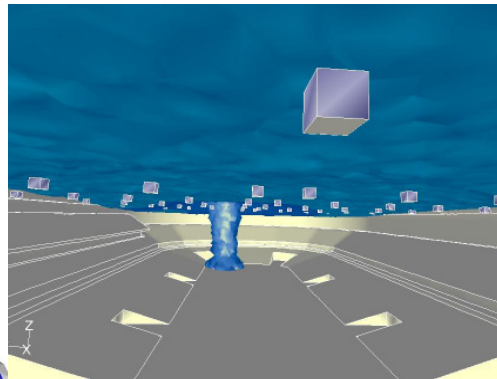

Smoke dispersion in Sport Arena

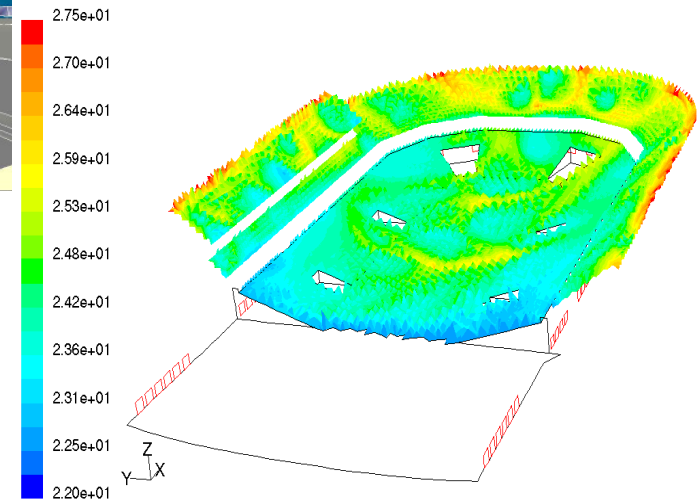

Temperature in Sport Arena

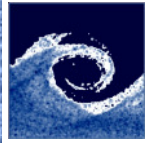

Application of CFD in energetics

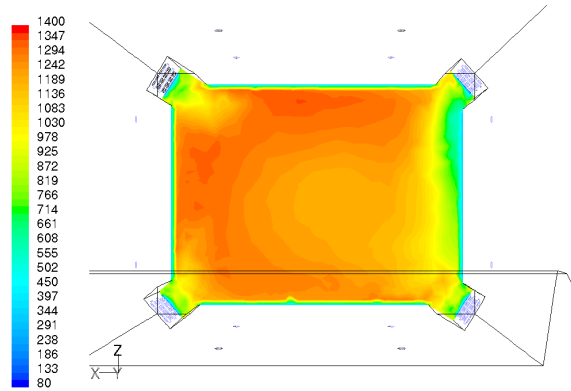

ERBE Oroszlany, Basic case
Contours of Static Temperature (c) May 18, 2002
FLUENT 6.0 (3d, segregated, pdf11, ske)

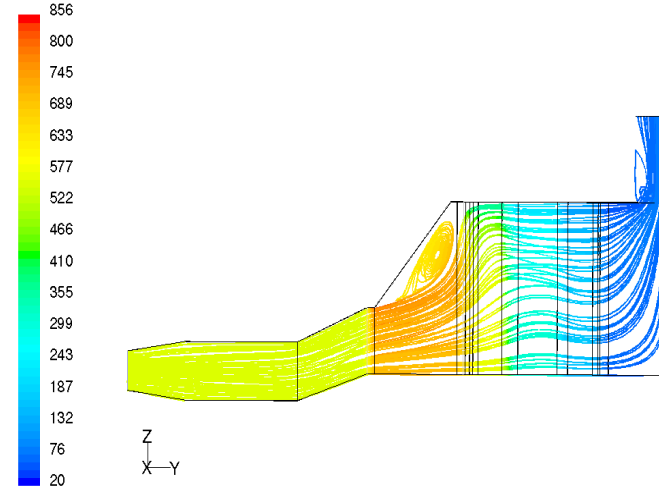

NO_x reduction in boiler

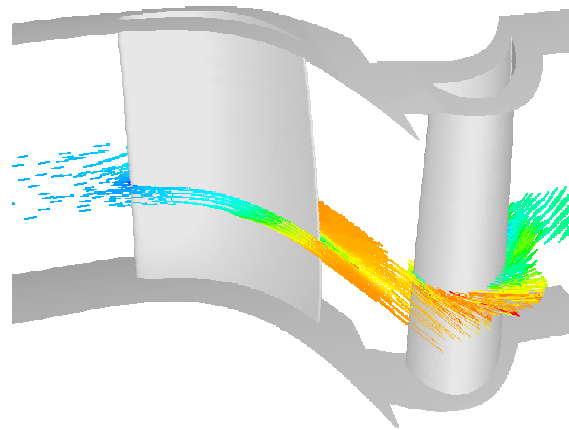

Simulation of flow in steam turbine stage

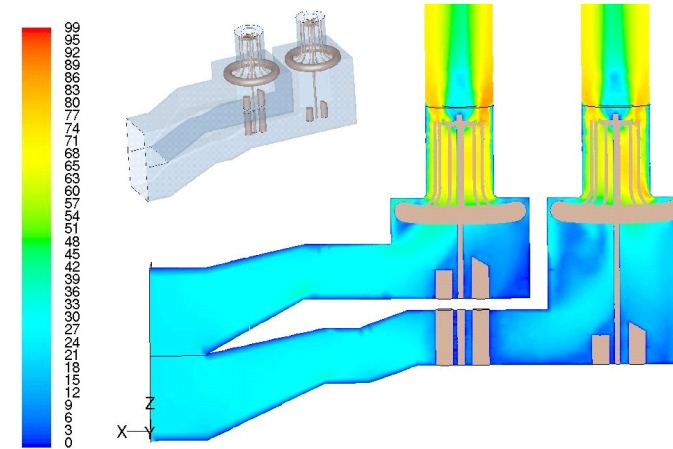

Contours of Velocity Magnitude (m/s) Jul 16, 2003
DERT Original Windbox FLUENT 6.1 (3d, segregated, mgke)

Optimization of flow in boilers

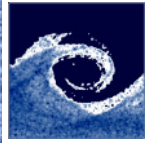

Coherent structure extraction

PIV measurements on a flow over a rectangular, open cavity

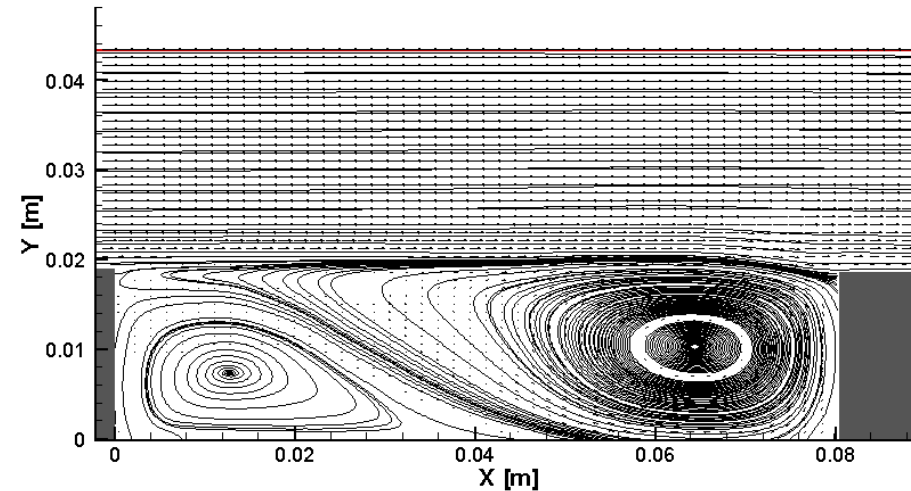

Extraction of coherent structures from turbulent flows by Proper Orthogonal Decomposition (POD)

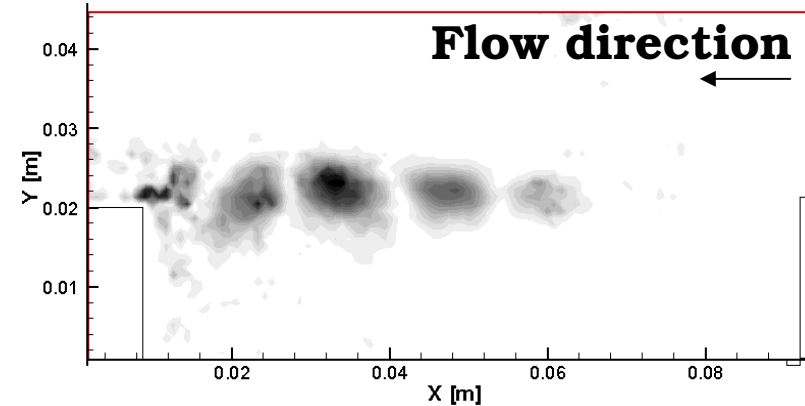
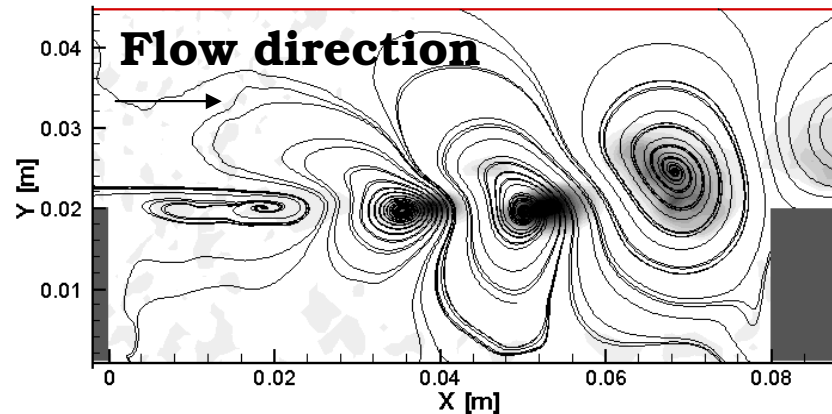

Coherent structures, which characterize temporal features (energetic vortex shedding process found by POD)

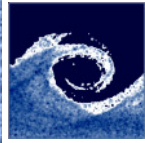

LES of flow past a Danube bridge: comparison of simulation and wind tunnel results, fluctuation of lift force

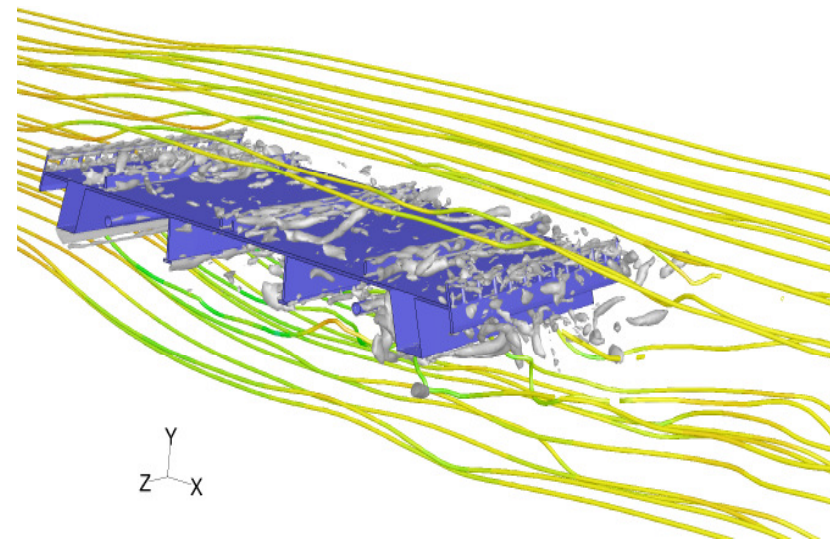
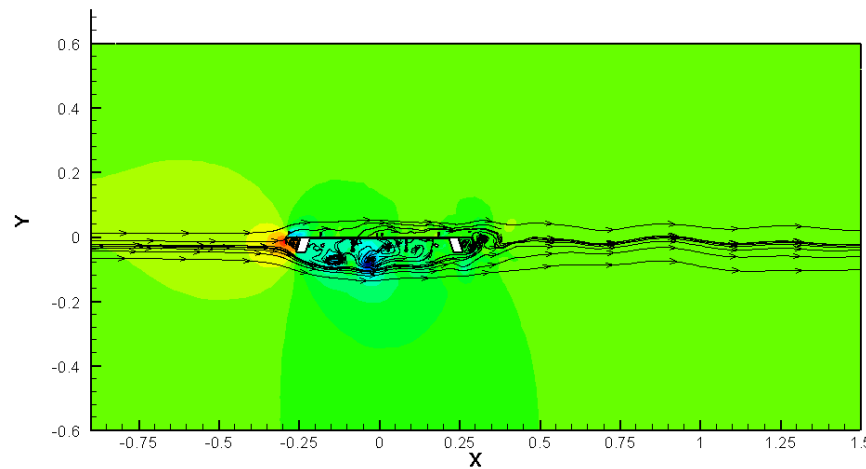
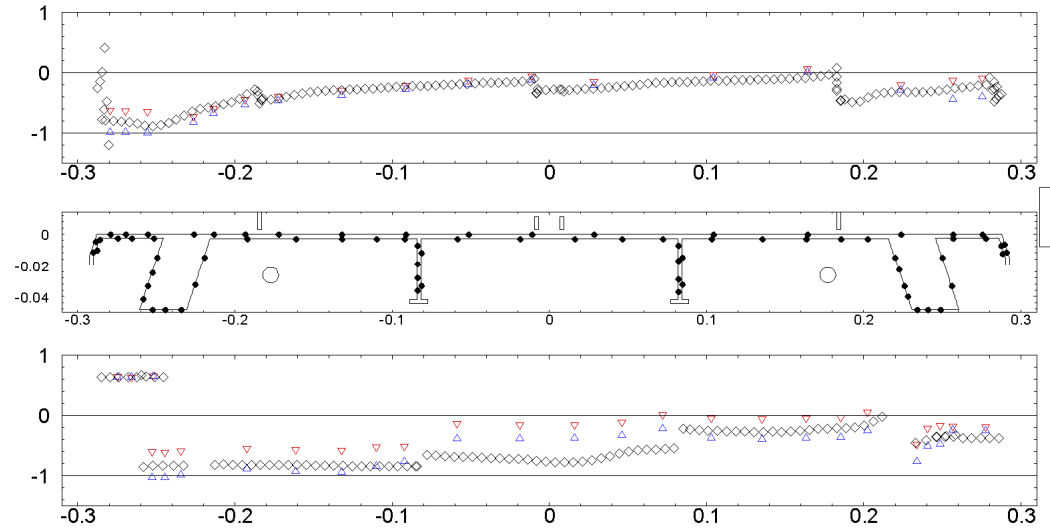
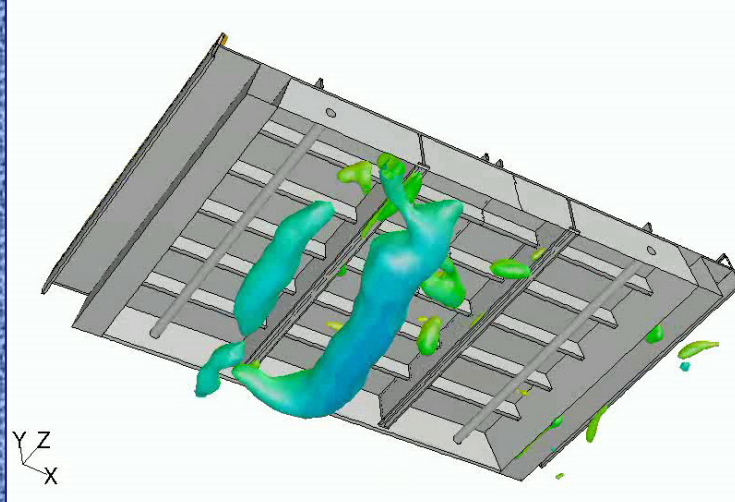

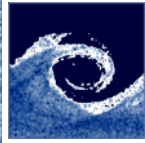

Description of turbulent ribbed duct flow, using results of Large Eddy Simulation

Application: internal cooling of turbine blades

Mesh, recirculation regions

Mixing by the mean flow

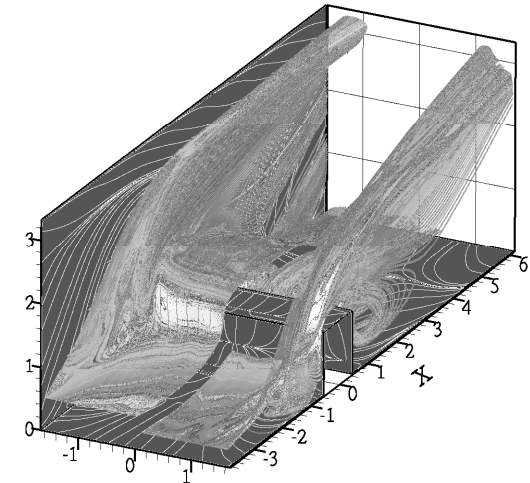
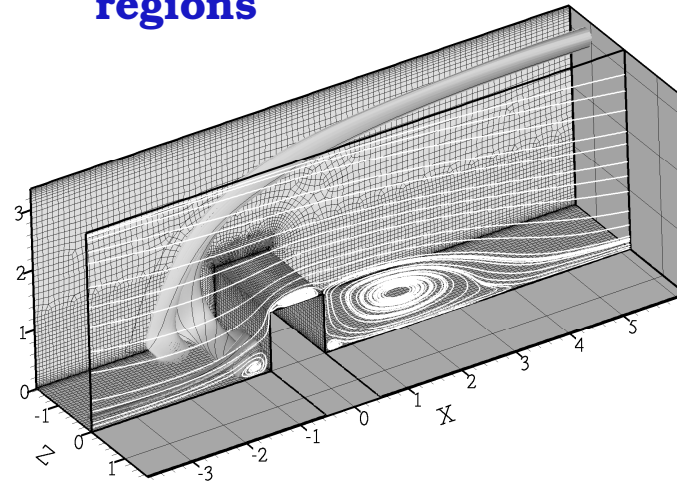
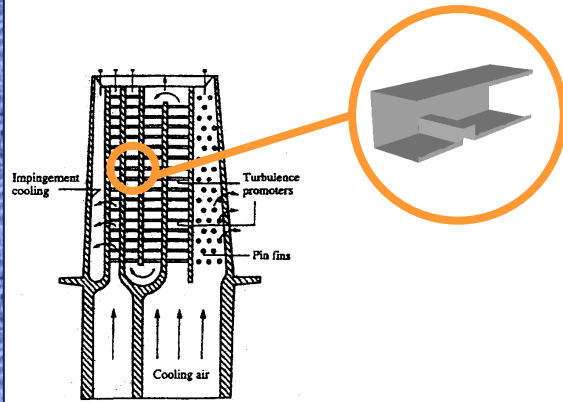

Validation to PIV measurement

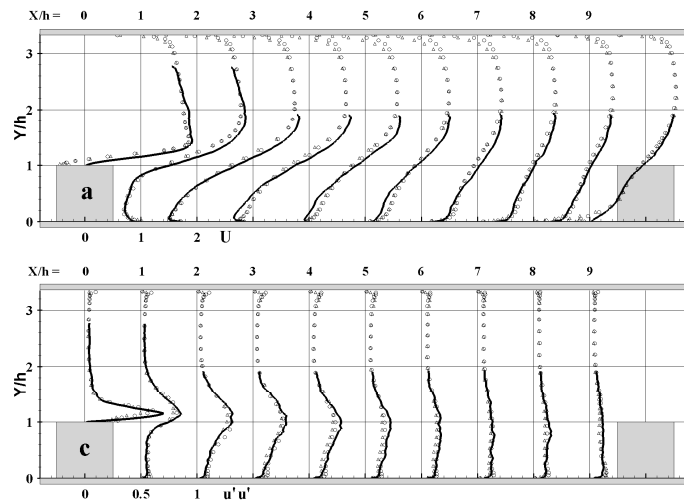

High TKE region

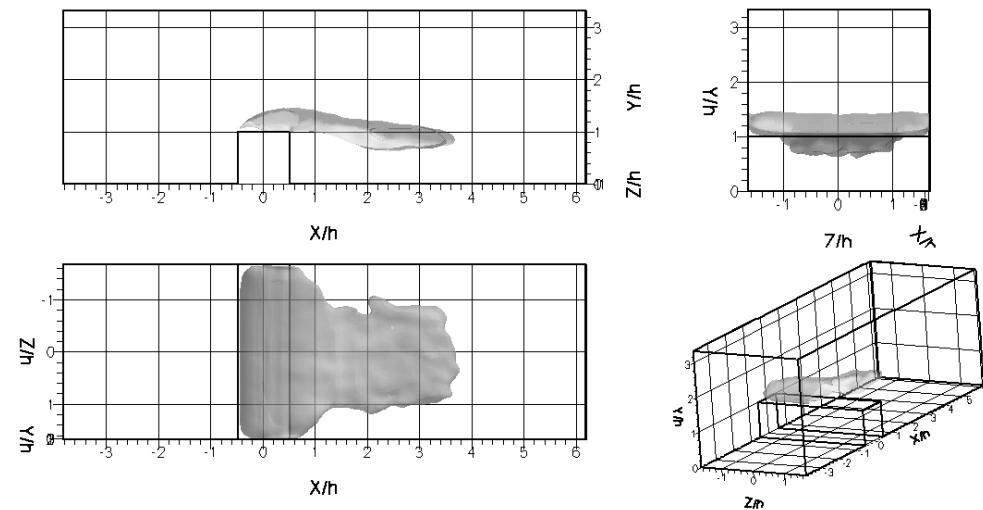

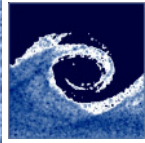

Conference on
**Modelling
Fluid Flow**
BUDAPEST / HUNGARY



September 3-6, 2003

Organized by
Department of Fluid Mechanics
170 papers from 30 countries

Conference Proceedings
of the previous CMFF'03
in Vol.I-II.

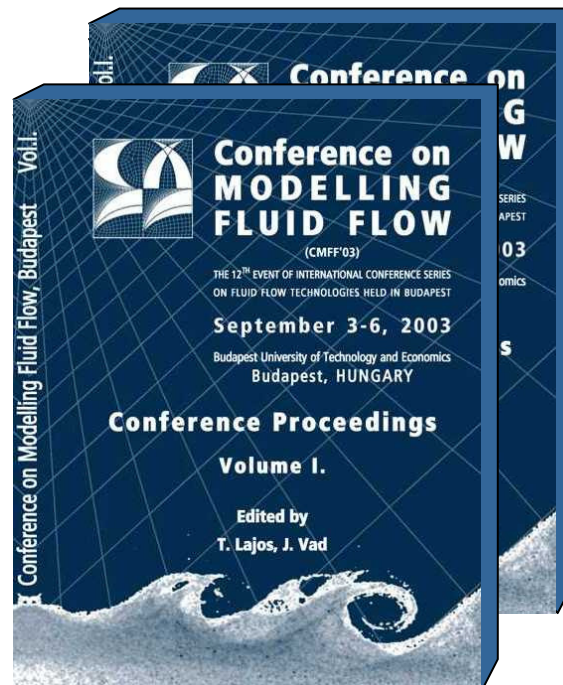

**NEXT CMFF
EVENT
in
2006**

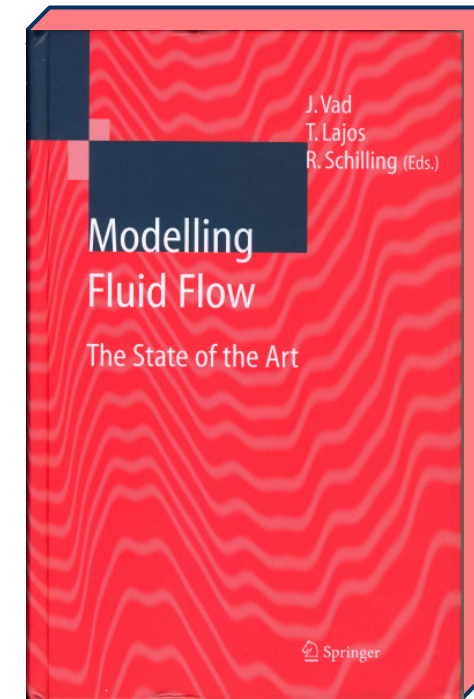

J. Vad, T. Lajos, R. Schilling (Eds.)

Modelling Fluid Flow / The State of the Art

-invited lectures

-summaries of workshops

-selected papers

SPRINGER Verlag 2004 ISBN 3-540-22031-3