

M1

THE INVESTIGATION OF THE DRAG COEFFICIENT OF DIFFERENT BODIES

1. Aim of the measurement

The investigation of a stationary object (e.g. a building) or a moving object (e.g. a vehicle), on which the wind force is acting, is an important issue. The aim of this measurement is to determine the forces acting on the model bodies, to calculate the drag coefficients of the bodies with the help of the measurement data and then conclude the results.

2. Description of the measurement equipment

The air flow, in which the measured objects will be placed, is brought about using a measurement cart. The constant velocity profile, which is brought about at the outlet of the cart, is produced by the confuser and the flow straighteners found upstream of the outlet. Two reference pressure taps can be found on the confuser,

which are used to help calculate the average velocity in the outlet cross-section. The velocity can either be controlled with the help of a frequency convertor or a choke. The force acting on the body is measured with the help of a cantilever arm and an electronic scale.

3. Description of the measurement

3.1 Different models are available, from which we can either choose three models with the same shape (cylinder, cone, sphere) and size, but having different roughnesses. Another option is to choose three bodies having the same shape and roughness, but different size. During the measurement the sphere must also be measured.

3.2 Measure the size of the different bodies, which have already been selected while taking note of the shape (e.g. the sphere can be taken apart for the diameter measurement) and roughness parameters. During the process one of the group members needs to check the temperature and pressure in the laboratory. This data is important, because later we need to calculate e.g. the density of the air.

3.3 We have to measure at three different air velocities. The equation for the calculation of the air velocity can be found on the side of the measurement setup. It is practical to choose the three different velocities so as to not forget about the two key parameters: the measurement range and the sensitivity of the measurement apparatus. The outflow velocity can be set between 7 and 25 m/s, and therefore the preferred velocities are e.g.: $v_1=8$ m/s, $v_2=16$ m/s and $v_3=24$ m/s.

It is necessary to calculate the proposed velocities according to the equation mentioned above. There are two static pressure holes on the confuser, to which need to be connected the digital manometer ports as we set up the pressure difference on the device. We can change the pressure difference and because of this, the outflow velocity, with the help of the choke, which can be found on the side of the device. If we want to get an appropriate change in the pressure difference, then we must turn more on the lever.

With one setup it is highly recommended to measure all of the bodies that we have and then choose a different velocity and start the same process again.

3.4 Place the chosen body in the flow. For this we have to fix the body to the **beam**. In this case we measure the acting force on the body and on the beam as well, but we want to know only the acting force on the body. Therefore the next step is to fix the body to the **“stand”**. (You should keep some distance between the body and the beam) This is very important, because in this case the flow field will be the same, but we measure only the force acting on the beam. After we subtract these two results from each other, we get the force acting on the body.

We need to make the measurement of the bodies in two steps:

a.) Fix the body to the beam, when the fan is not running and set the balance to zero. Next, switch on the fan and note the measured force on the sheet. Pay attention to make sure that the correction is made for the force of the arm-ratio on the balance. To know the arm-ratio of the

balance we have to measure the lengths of the arms. Hence we find the force acting on the body and on the beam.

b.) To continue the process, switch off the fan. Then fix the body on the stand **and leave the beam free**. We have to pay attention not to connect the body to the beam. Set the electric balance to zero while the velocity of the outflow is zero. It is practical to cover the outflow cross-section with a booklet after the fan has been switched off. /*/ It is not necessary to wait till the fan has totally stopped. After following this procedure the force acting on the beam has been found.

Finally we get the force acting on the body, if we subtract these two results.

We must repeat the steps mentioned above in section 3.4 for all of the bodies.

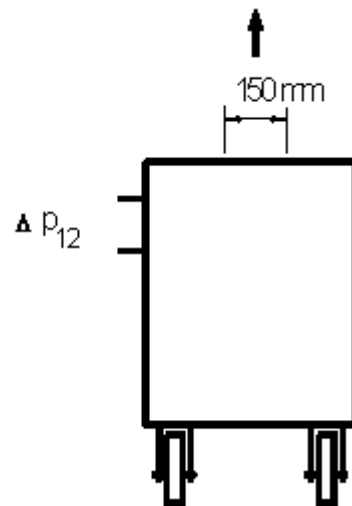
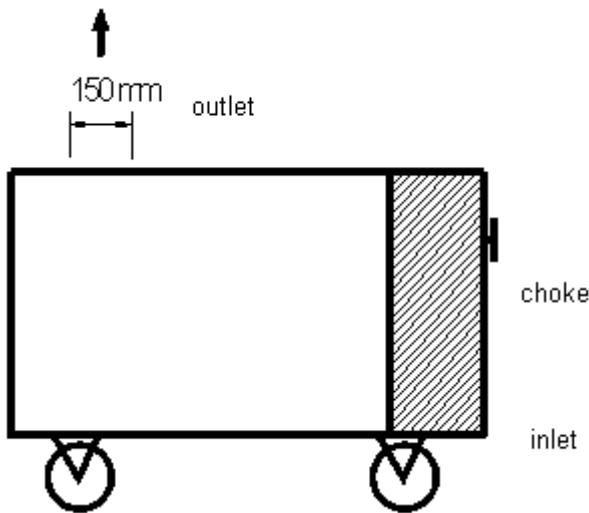
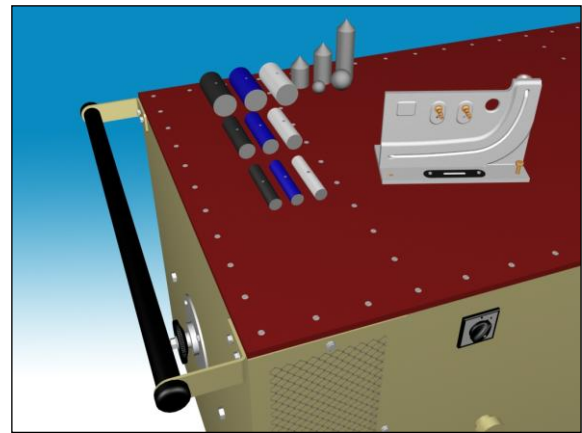
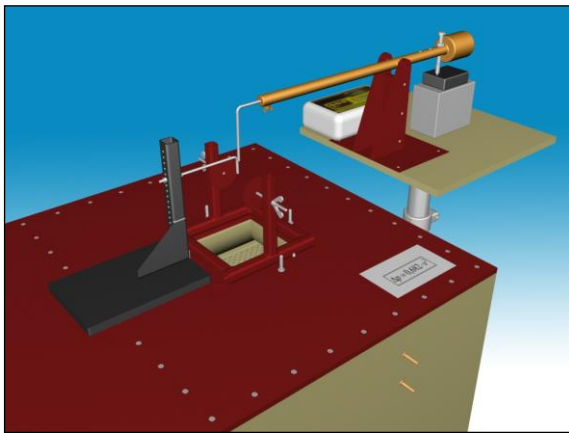

4. The evaluation of the measurement

4.1 Note down in a table the data measured and calculated before.

The equation for the calculation of the drag coefficient:

$$C_d = \frac{F}{\frac{\rho}{2} v^2 A}$$

$F [N]$ the acting force on the body

$\rho \left[\frac{kg}{m^3} \right]$ density of the air (you should calculate it)

$A [m^2]$ the cross-section of the body (the cross-section is perpendicular to the direction of the unperturbed flow)

$v \left[\frac{m}{s} \right]$ velocity of the air

4.2 Plot a graph on which the value of the calculated drag coefficient as a function of roughness (or diameter, length, cone angle) is shown. For example, if we had chosen three bodies in similar diameter, we could plot the drag coefficient as a function of roughness. We need to make it obvious, which values belong to which velocity. (Since we don't know the value of the roughness, we can't correlate these values to each other. Furthermore, in the case of roughness the points on the graph cannot be joined to each other.)

4.3. Draw the drag coefficients as a function of Reynolds number for all of the four bodies. The way you can calculate the Reynolds number is:

$$Re = \frac{vd}{\nu}$$

,where

$v [m/s]$ velocity of the air

$d [m]$ the characteristic size (In the case of spheres and cylinders this size is the diameter. In other cases you should ask the tutor, who is coordinating the measurement about this.)

$\nu \left[\frac{m^2}{s} \right]$ the kinematic viscosity of the air (You can find an excel sheet on the department webpage, which contains the data.)

4.4. The error calculations can be done according to the following instructions. The calculations should be made for the quantities requested below, and should be presented together with the calculated results.

The definition of the drag coefficient and the calculation of its absolute error:

$$c_d = \frac{F}{\frac{\rho v^2 A}{2}} \qquad \delta c_d = \sqrt{\sum_{i=1}^n \left(\delta X_i \cdot \frac{\partial c_d}{\partial X_i} \right)^2}$$

The relative error:

$$\frac{\delta c_d}{c_d} = ?$$

Where X_i are the measured quantities and the related measurement errors:

$$X_1 = F \qquad \delta F = 0.02[N]$$

$$X_2 = p_0 \qquad \delta p_0 = 100[Pa]$$

$$X_3 = T_0 \qquad \delta T_0 = 1K$$

$$X_4 = \Delta h \qquad \delta \Delta h = 0.001[m]$$

$$X_5 = \Delta h_{Betz} \qquad \delta \Delta h_{Betz} = 0.0001[m]$$

$$X_6 = \Delta p \qquad \delta \Delta p = 2[Pa]$$

Remember that during the labs:

- Before turning any measurement device on, or in general during the lab, make sure that safe working conditions are ensured. The other participants have to be warned of the starting of the machines and of any changes that could endanger the members of the lab group.
- The atmospheric pressure and room temperature should be recorded before and after every measurement..
- The measurement units and other important factors (e.g. data sampling frequency, date of calibration) of every recorded value of the applied measurement devices should be recorded.
- Type and construction number of the applied measuring instrument should be included in the final report.
- Checking and harmonizing of the units of the recorded values with those used in further calculations.
- Manometers should be calibrated if necessary.
- The measurement ports of the pressure meter should be carefully connected to the correct pressure ports of the instrument.
- If inlet or outlet tubes are to be assembled with fans, connections should be airtight as escaping/entering air can significantly modify the measurement results.

It's useful to compare your data to the data from the literature:

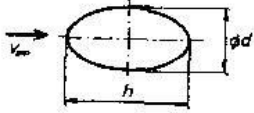
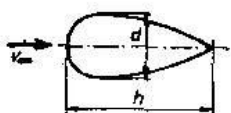
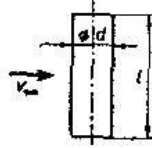
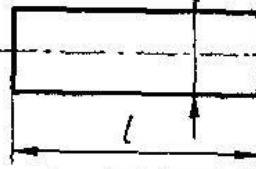
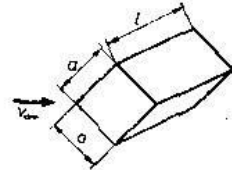
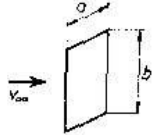
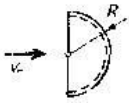
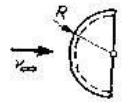
Test	Méretarány	c_e	
		$R \approx 10^4 + 10^6$	$R > 5 \cdot 10^6$
Forgási ellipszoid 	$h:d = 1,8$ 1 (gömb) 0,75 0 (körtárcsa)	0,5 0,6 1,1	0,09 0,15 0,2 1,1
Dúo 	$h:d = 2$ (hossza ∞) 3 5 10 20		0,2 0,1 0,08 0,089 0,094
Henger 	$l:d = 1$ 2 5 10 40 ∞	0,63 0,68 0,74 0,82 0,98 1,2	0,35
Henger 	$l:d = 0$ 1 2 4 7	1,11 0,91 0,85 0,87 0,099	
Hasáb 	$l:a = 5$ ∞		0,91 1,53
Téglalap 	$a:b = 1$ 2 4 10 18 ∞		1,10 1,15 1,19 1,29 1,40 2,01
Fél gömbhéj 			1,33
Fél gömbhéj 			0,34