

Épületek körüli áramlás

2009

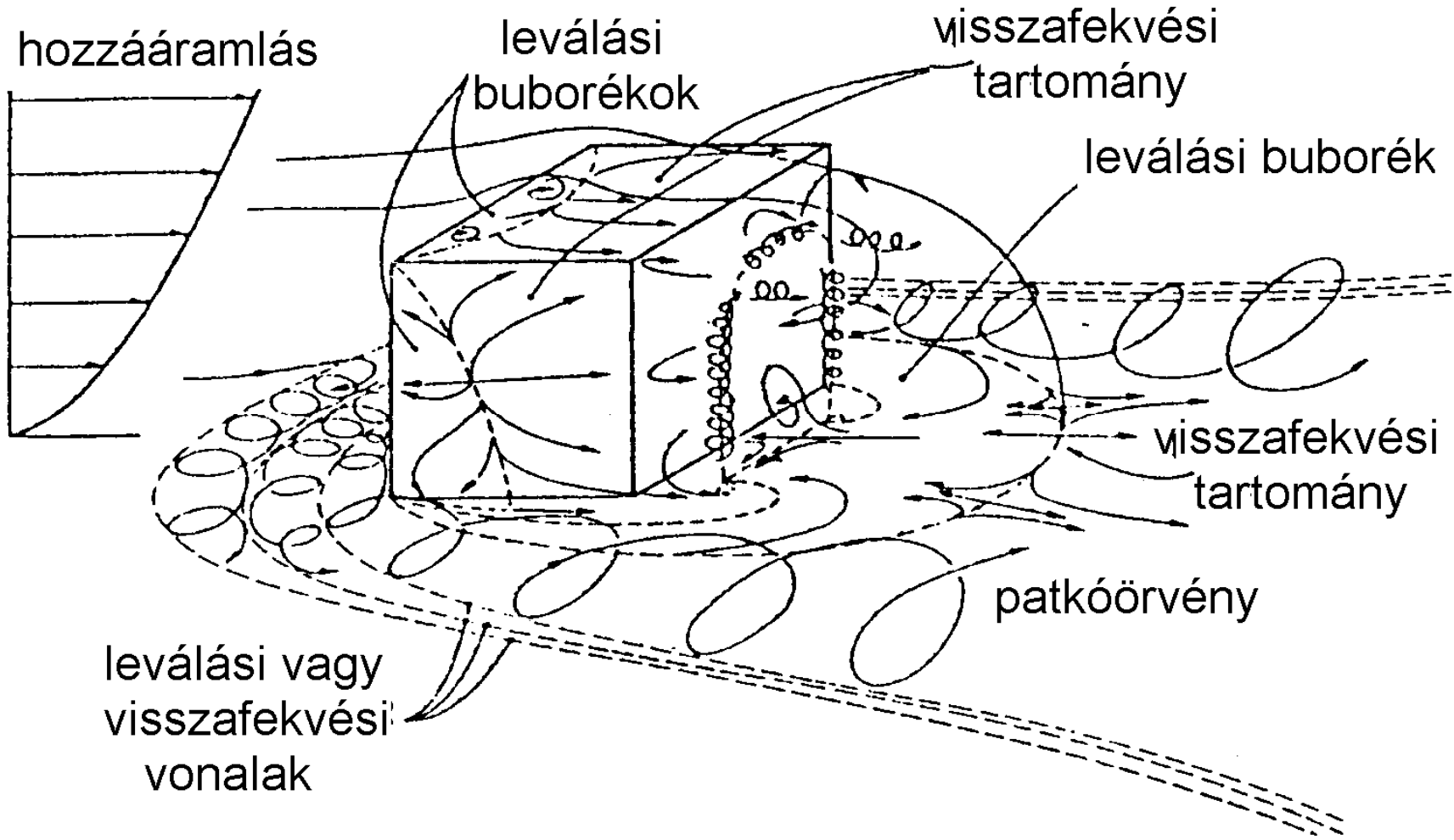

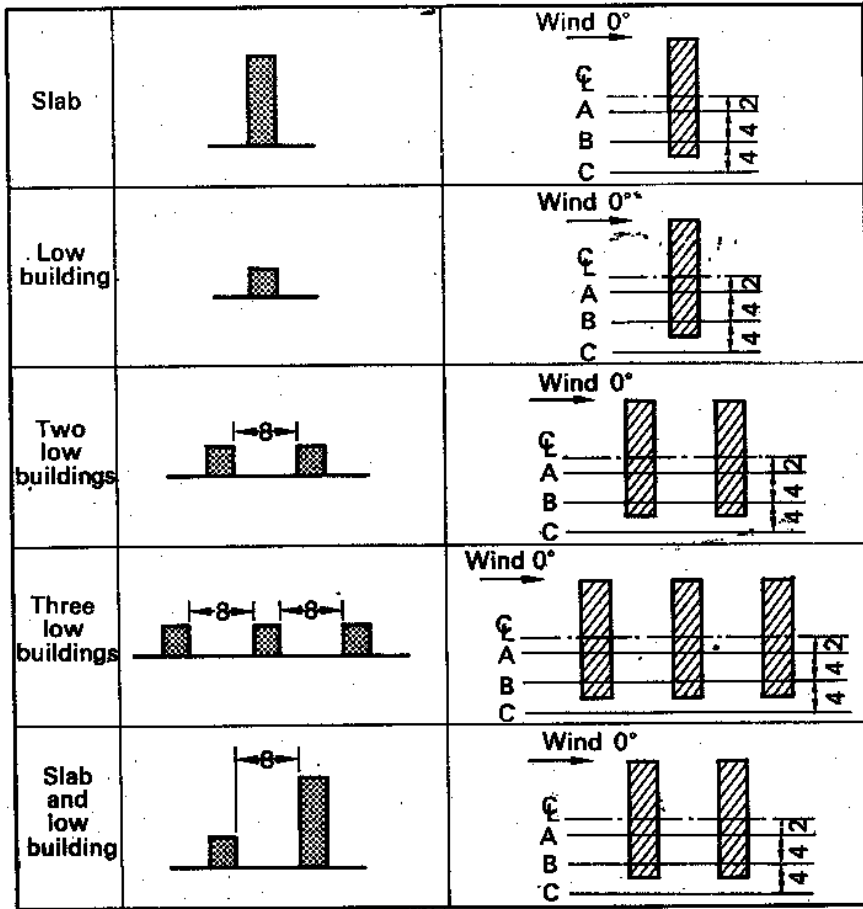

Dimensions, inches

FIG. 7.17. Arrangements of models and details of planes of traverse.

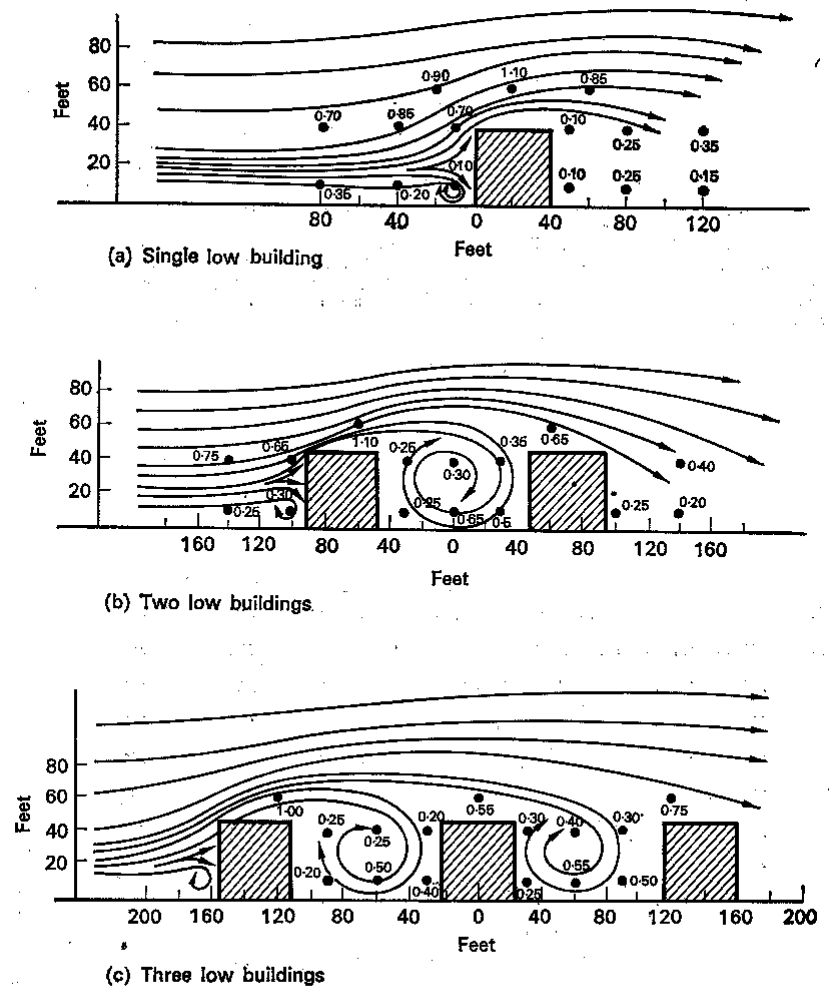
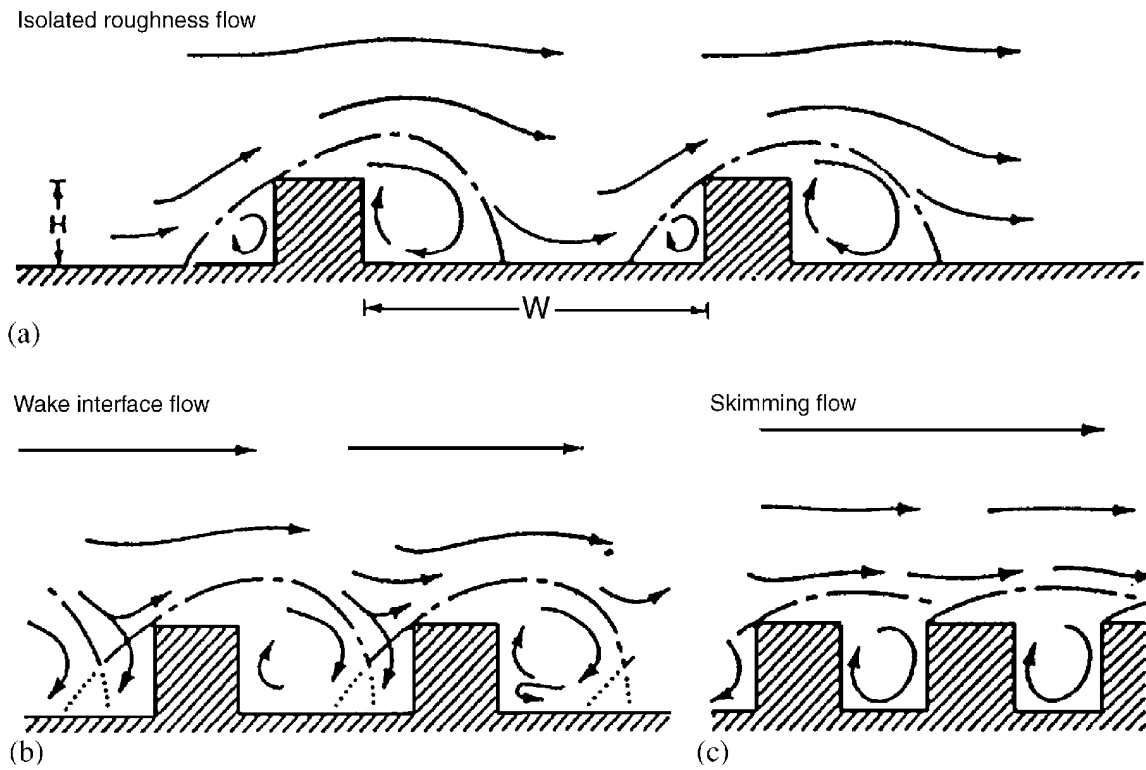
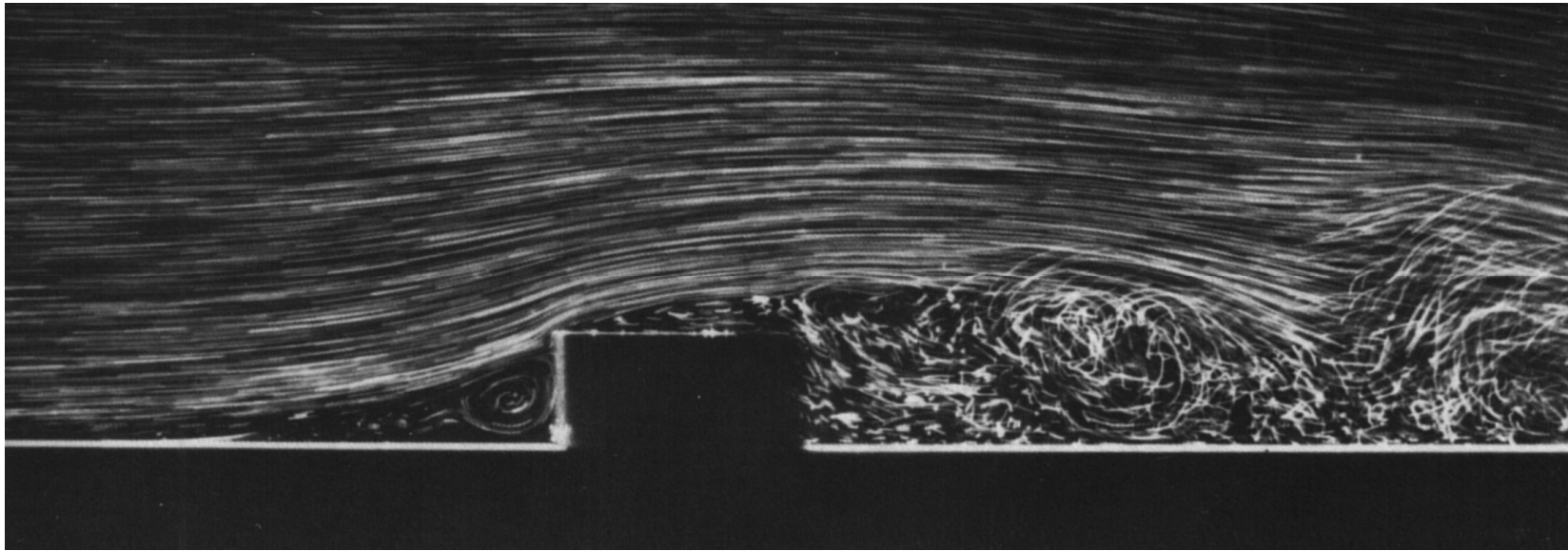

FIG. 7.19. Flow pattern on the centre line of one, two and three low buildings.⁽⁷⁷⁾
(Velocity = 1.0 at roof level, away from buildings).



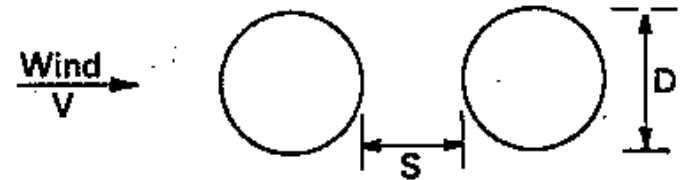
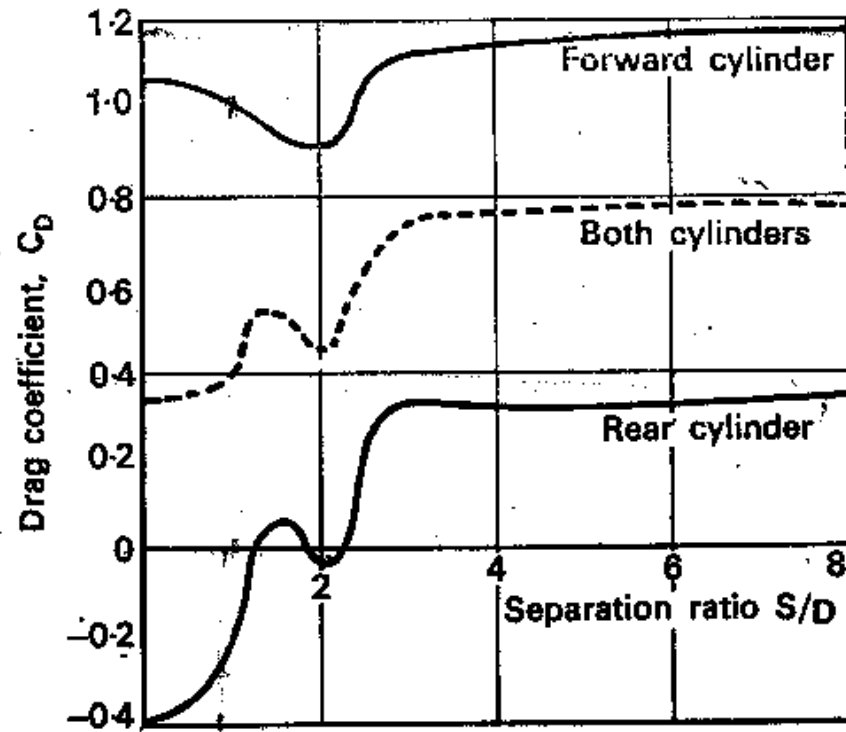

FIG. 3.13. Drag coefficient of two cylinders in line-of-wind.

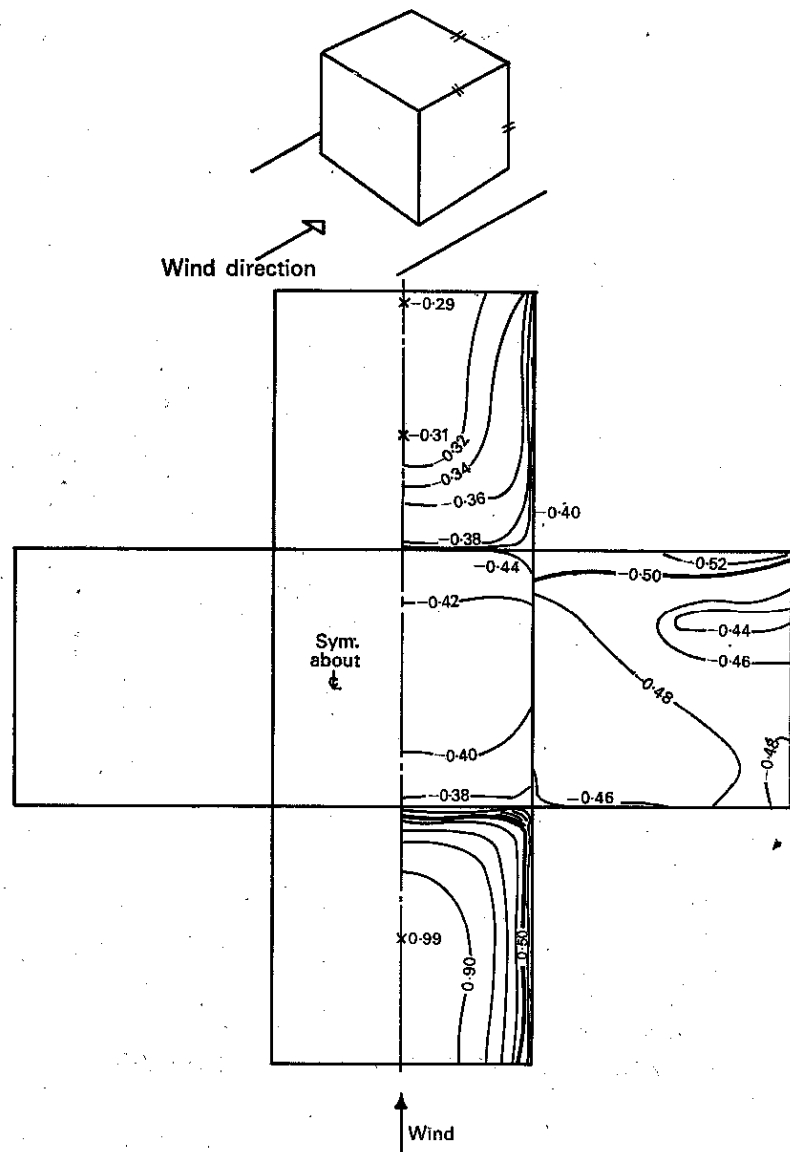

FIG. 3.8. Pressure distribution on a cube.⁽⁸²⁾

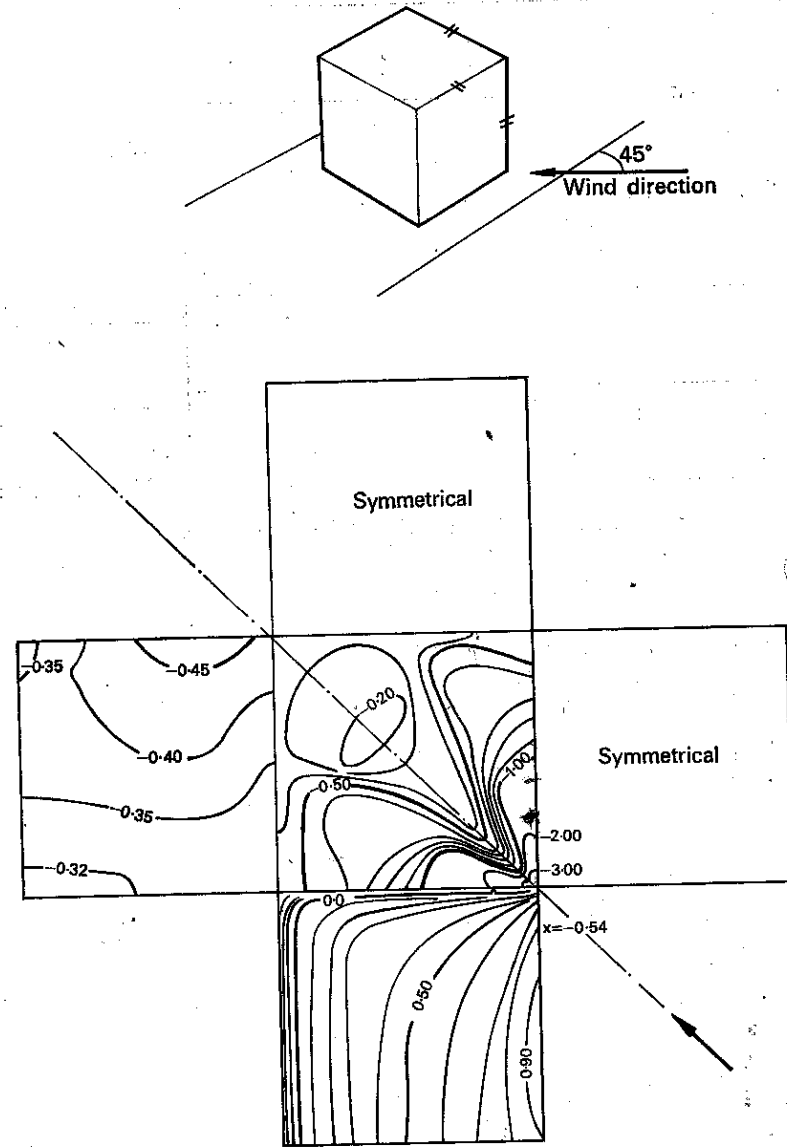

FIG. 3.9. Pressure distribution on a cube.⁽⁸²⁾

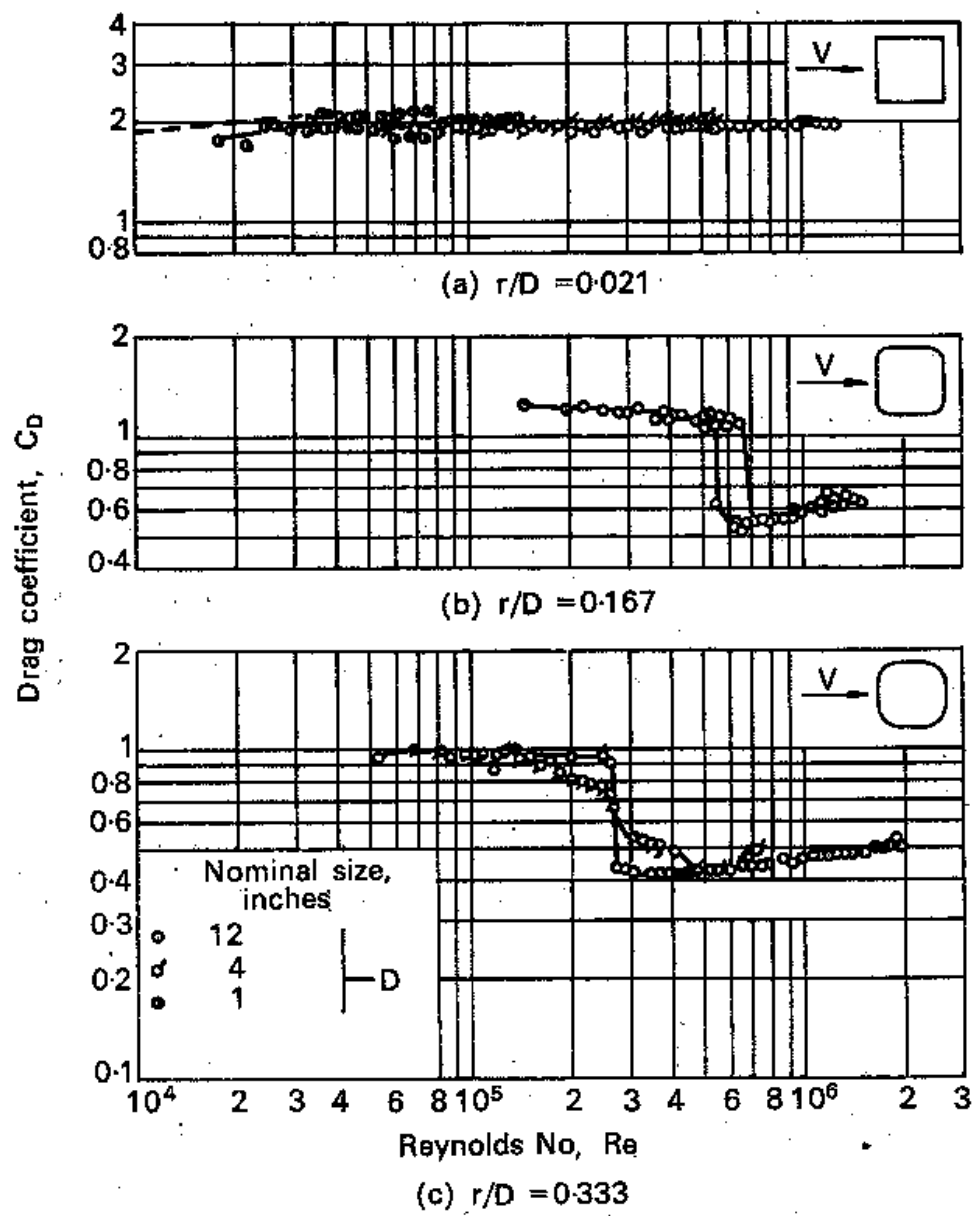

FIG. 3.12. Drag coefficients for square-section cylinders.⁽³⁶⁾

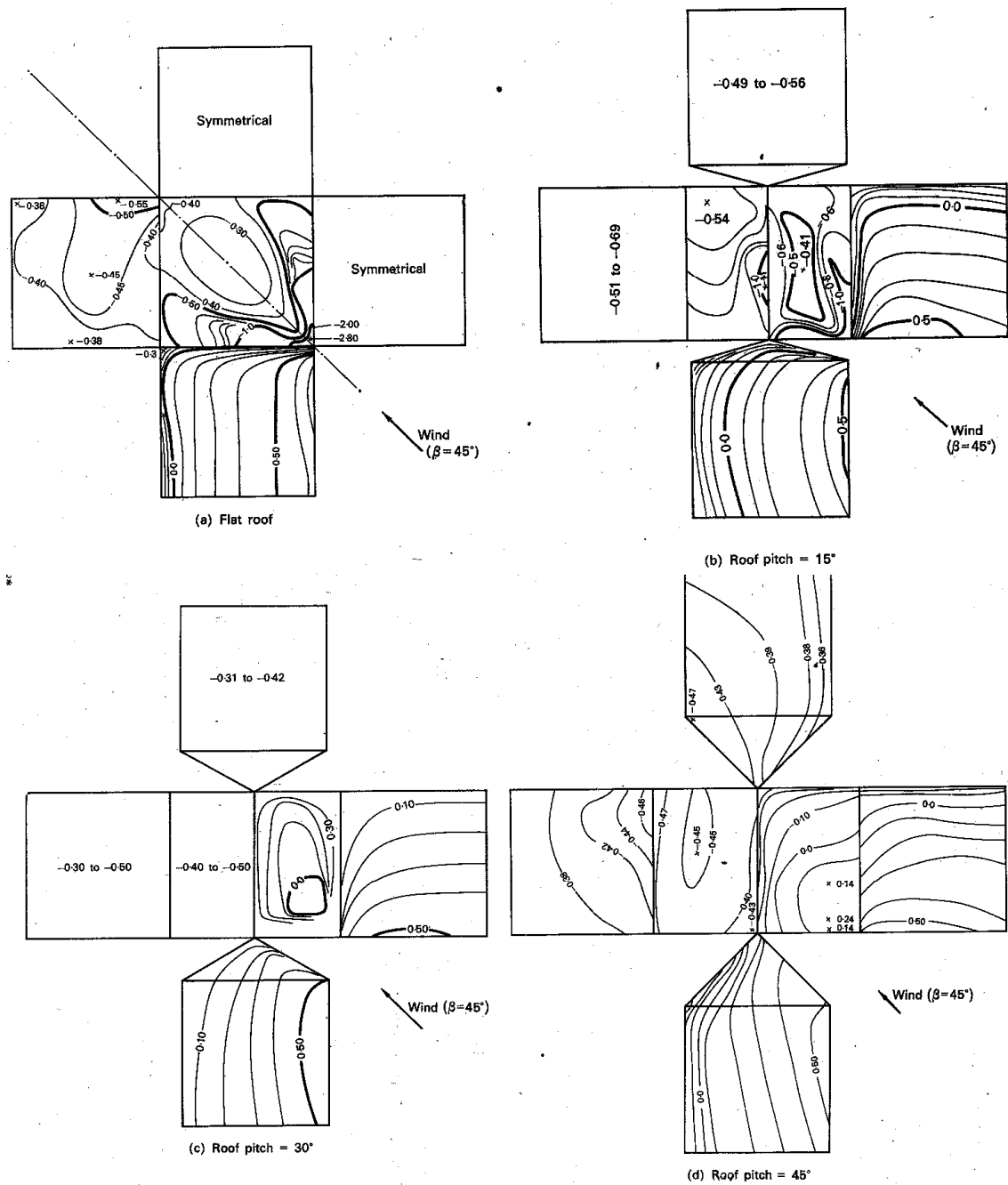

FIG. 7.6. Pressure distribution on a square building with various roof pitches.⁽⁸²⁾

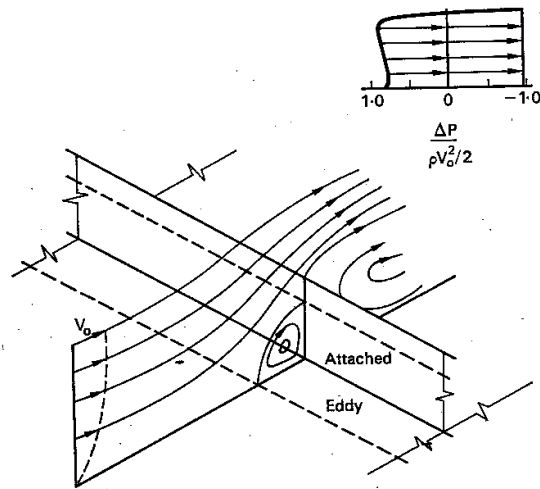
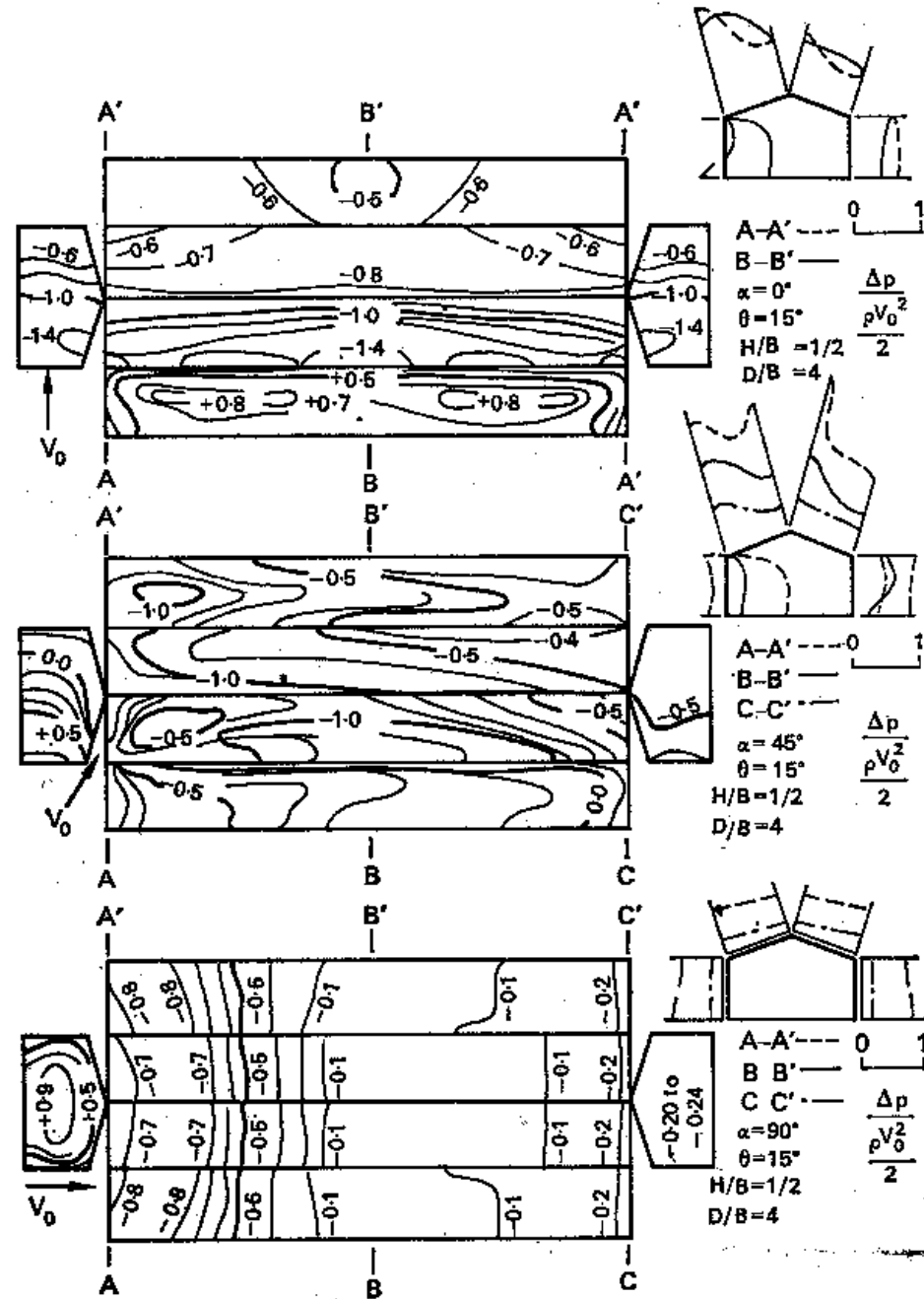
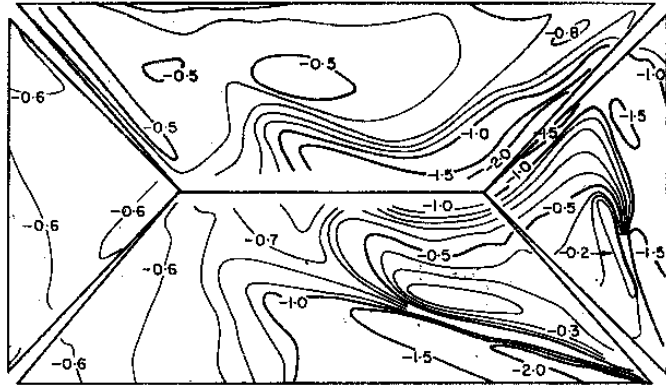

FIG. 7.4. Flow and pressure distribution on a long wall in a boundary-layer velocity field.⁽⁷⁸⁾



(a)



20° Hipped $\beta = 45^\circ$

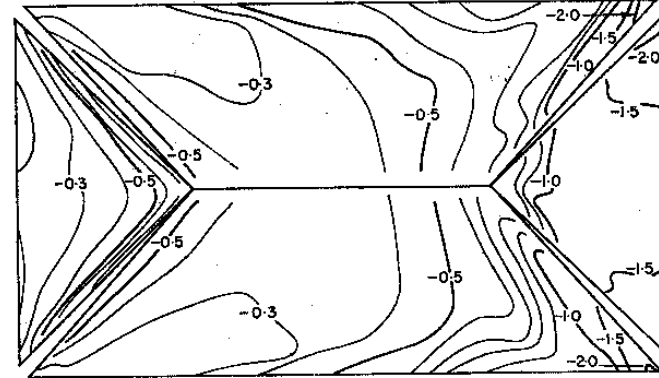
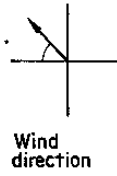

20° Hipped $\beta = 90^\circ$

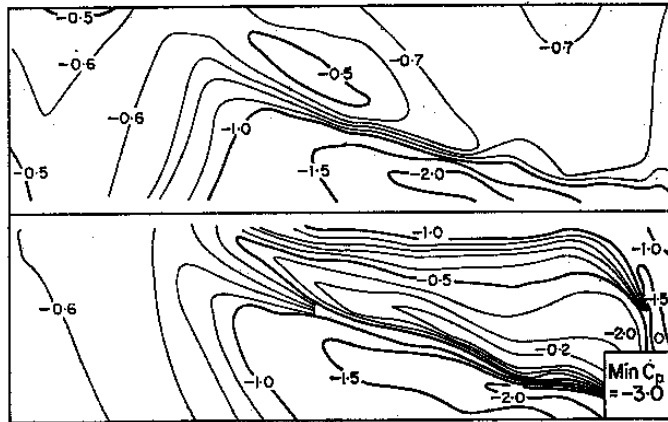
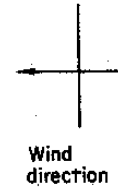

20° Gabled $\beta = 45^\circ$

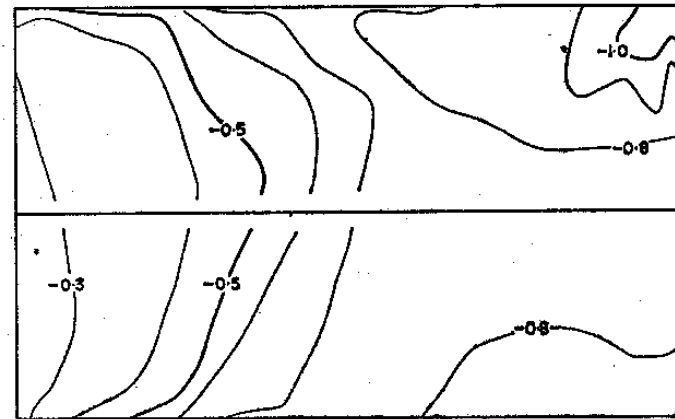

20° Gabled $\beta = 90^\circ$



(b) Pressure distribution for 20° pitched roofs

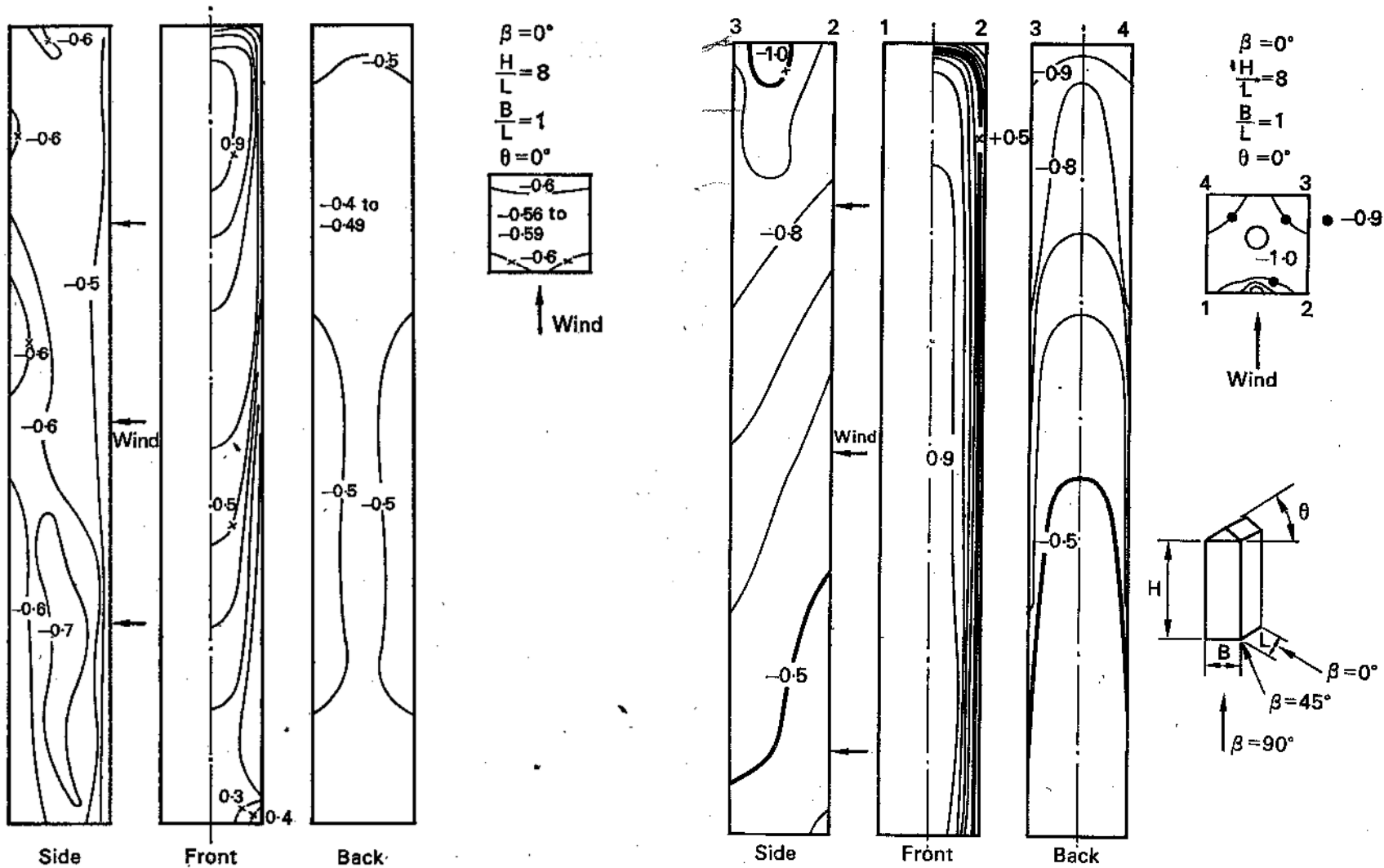

Pressure distribution, tall building in a boundary-layer velocity field (a). Pressure distribution, tall building in a constant velocity field. (referred to velocity at top of building).

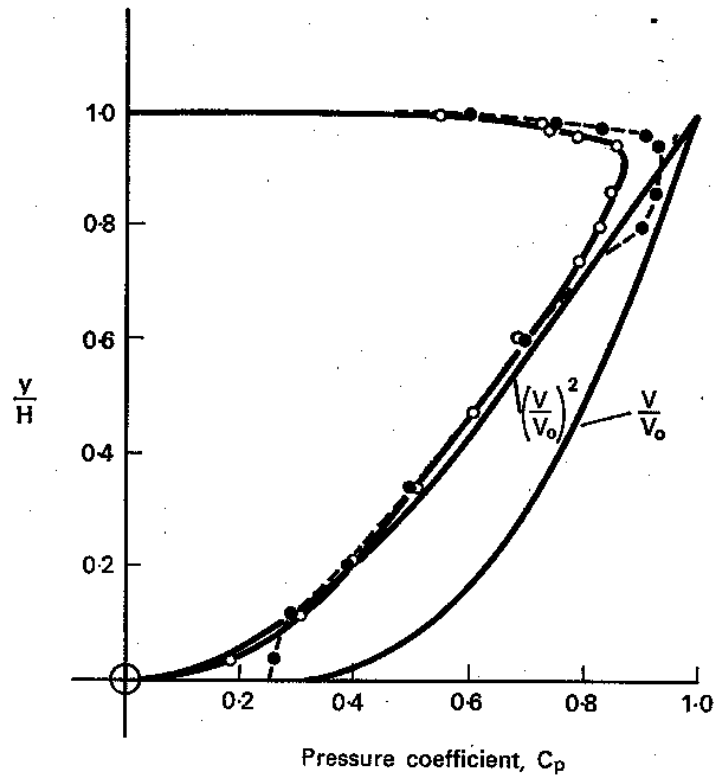

Pressure distribution on front centre line of tall building.⁽⁷⁸⁾ Wind yaw angle $\beta =$

○ Calculated, $= \frac{\Delta P}{\frac{1}{2}\rho V_0^2} \cdot \left(\frac{V}{V_0}\right)^2$ ($V_0 =$ reference velocity).

● Measured (model immersed in boundary layer).

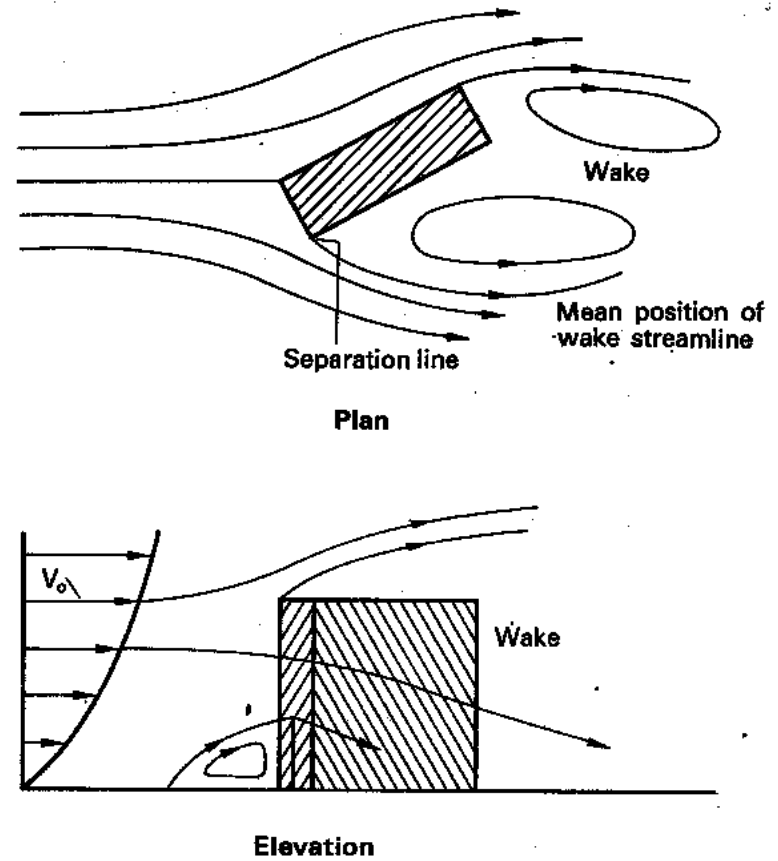

FIG. 7.1. Characteristics of wind flow over a building.⁽⁷⁸⁾

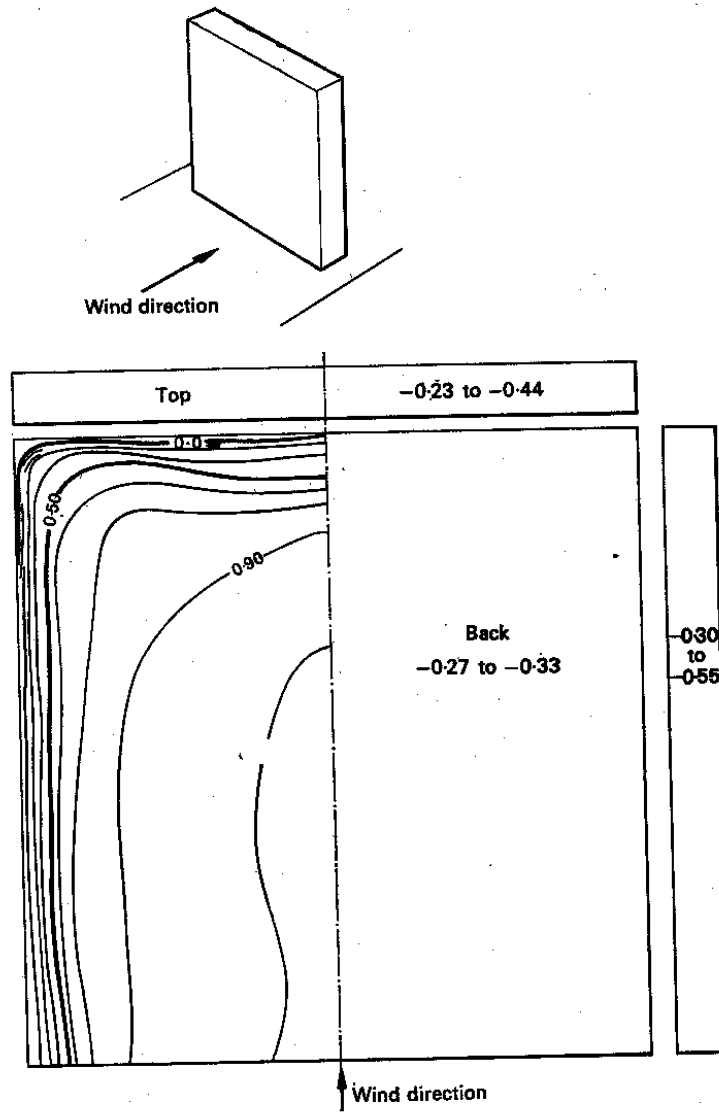

FIG. 3.7. Pressure distribution on a 12x12x1 in. wall.⁽⁸²⁾

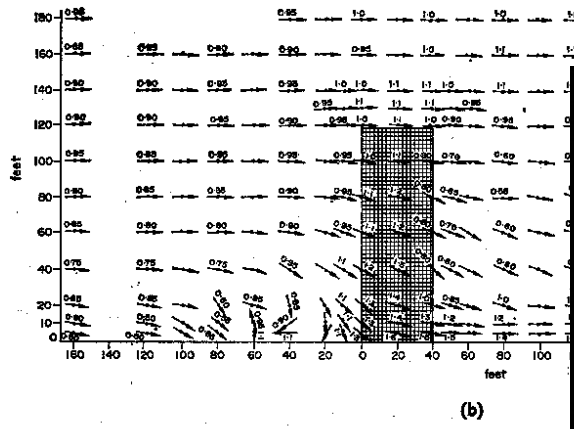
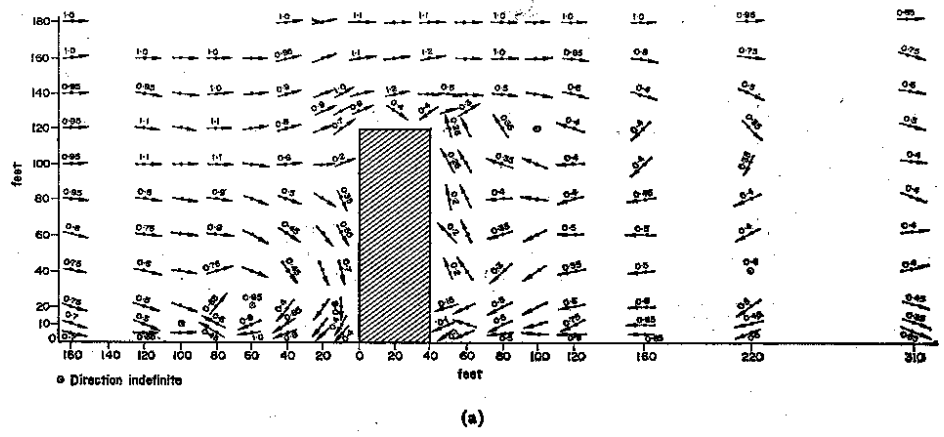

FIG. 7.18. Slab building in a wind tunnel.⁽⁷⁷⁾ (a) Gradient

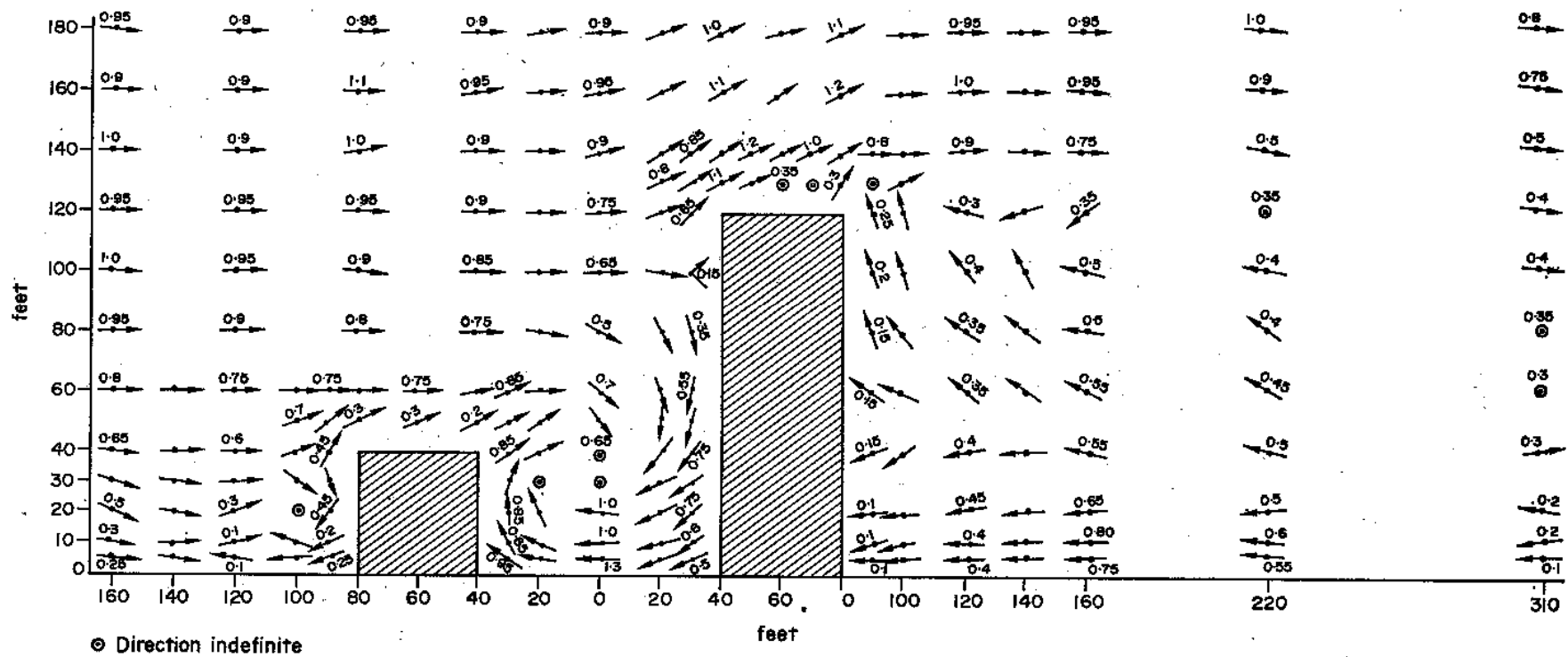
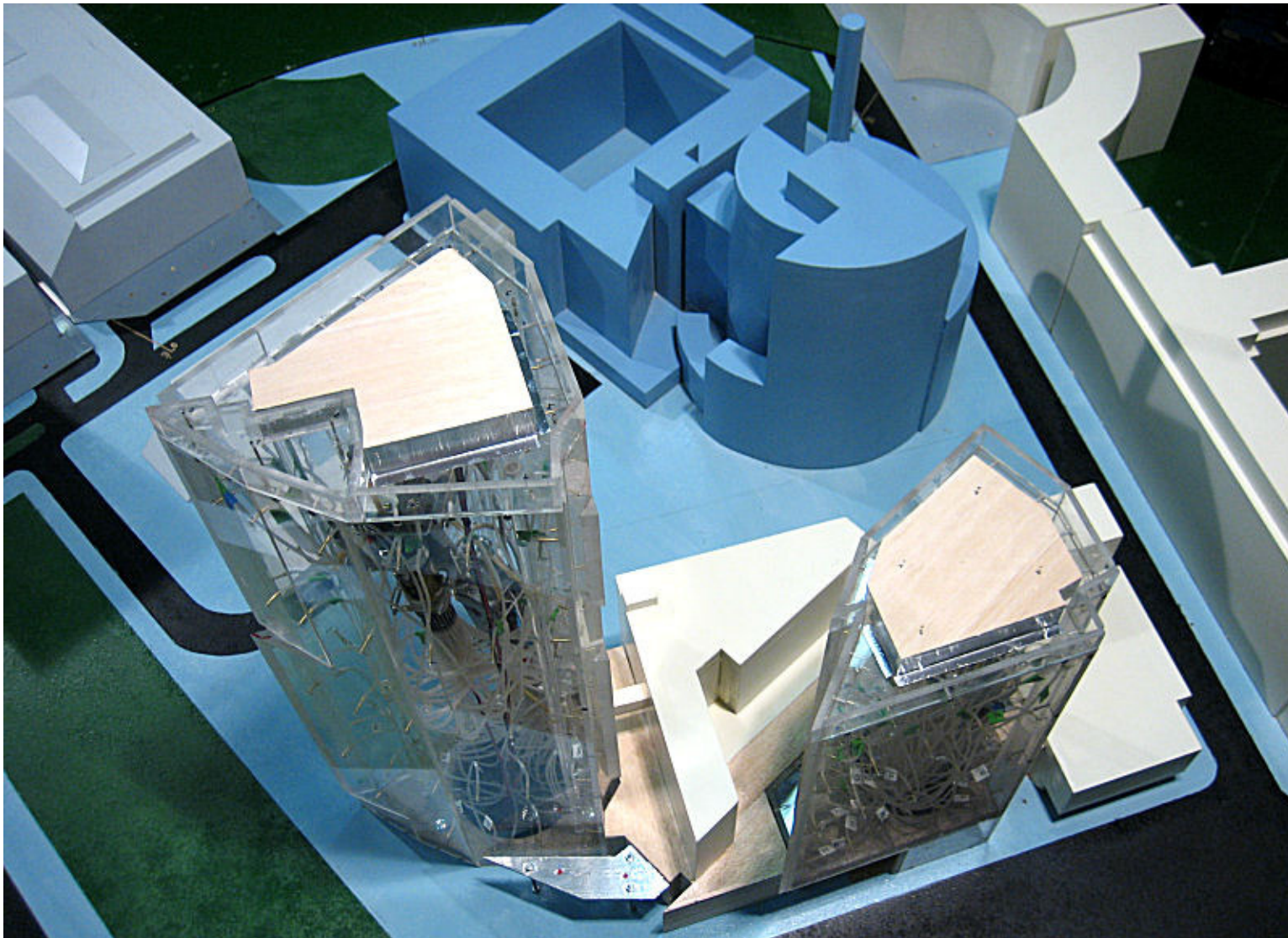
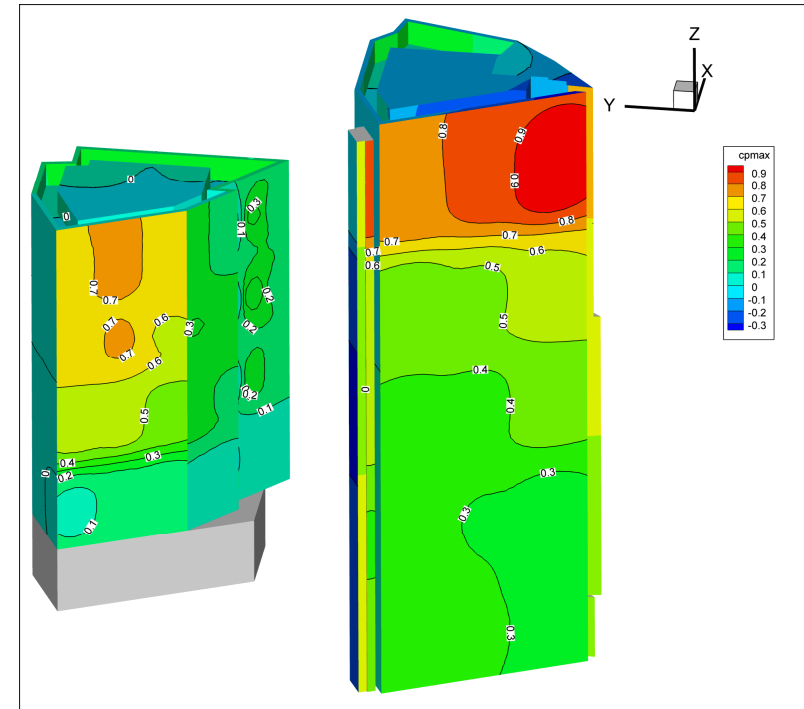
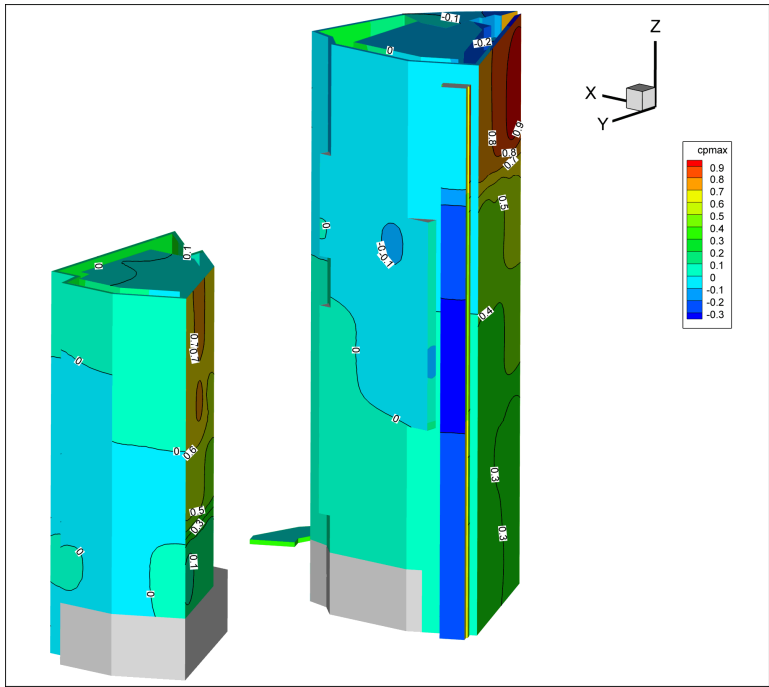
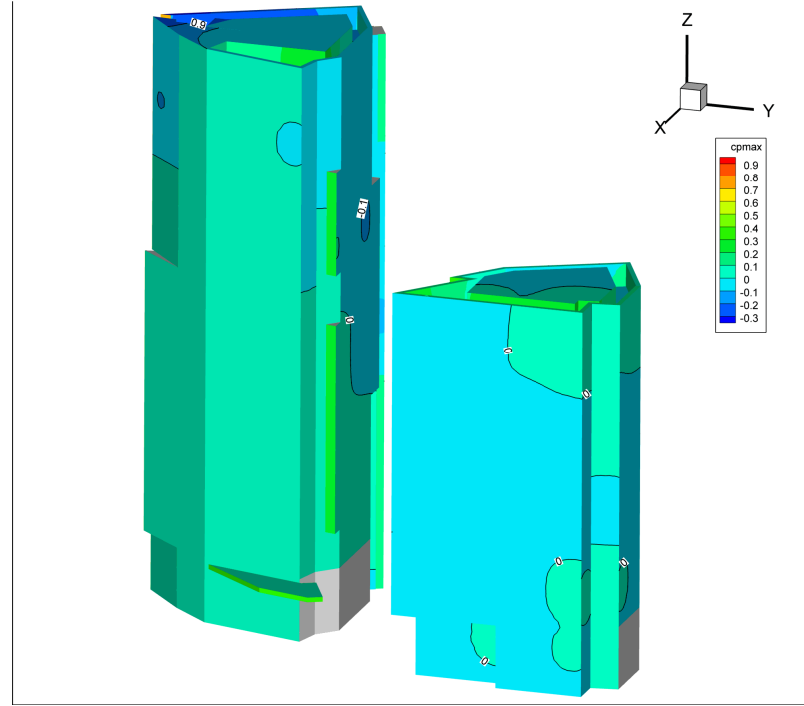
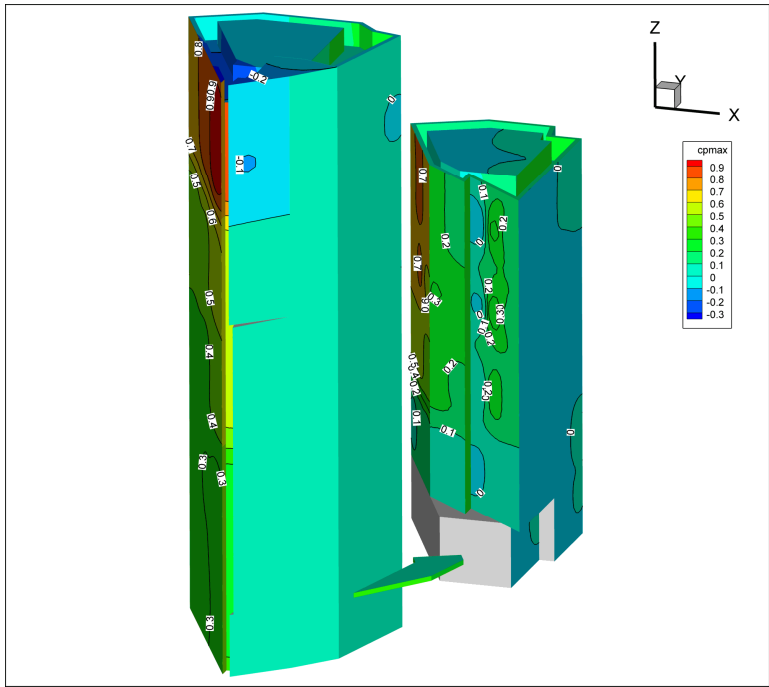
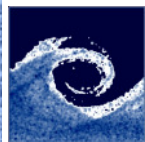

FIG. 7.20. Slab and low building in a gradient wind velocity.

A Raiffeisen tornyok szélcsatorna vizsgálata







Az áramlás numerikus szimulációja

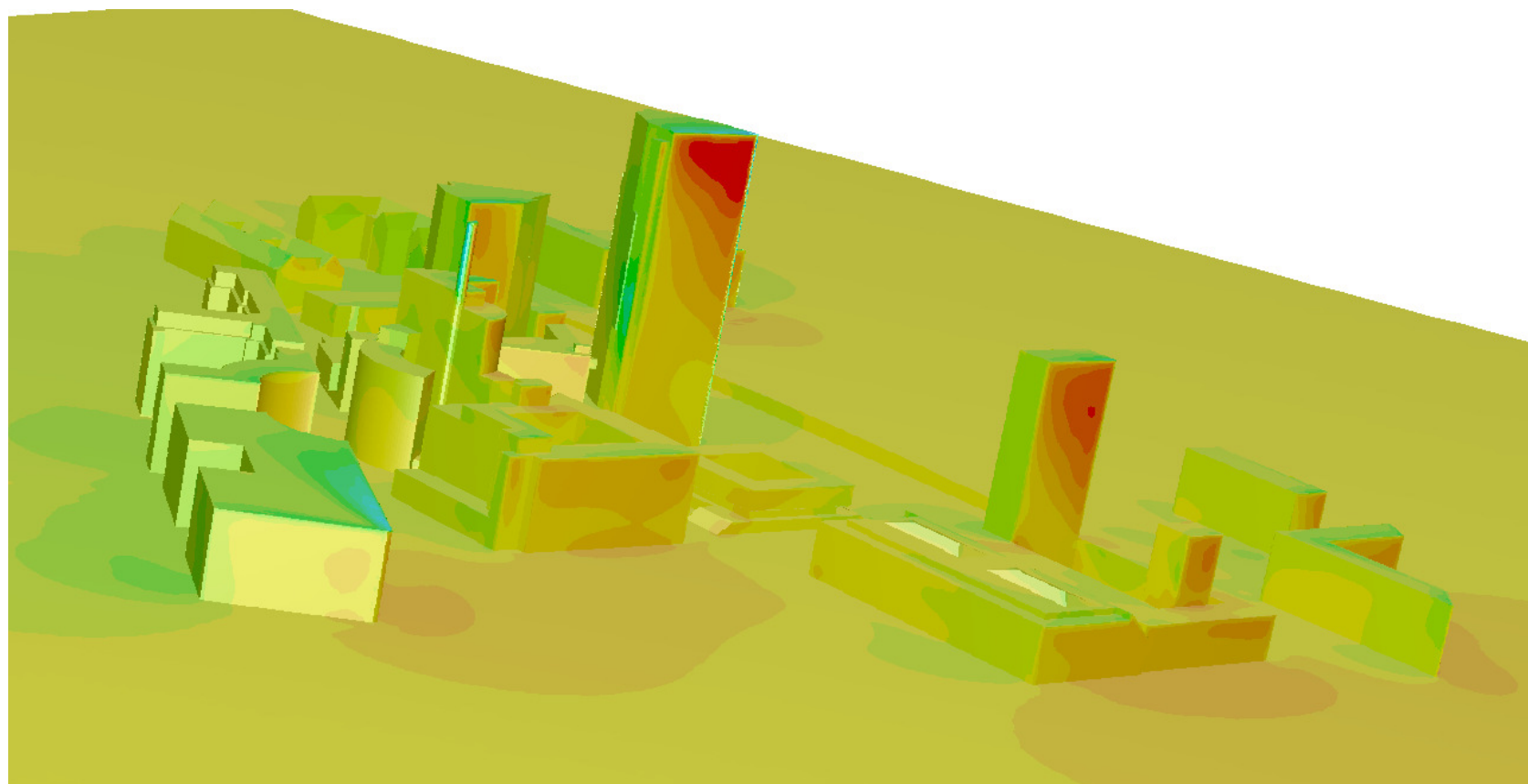



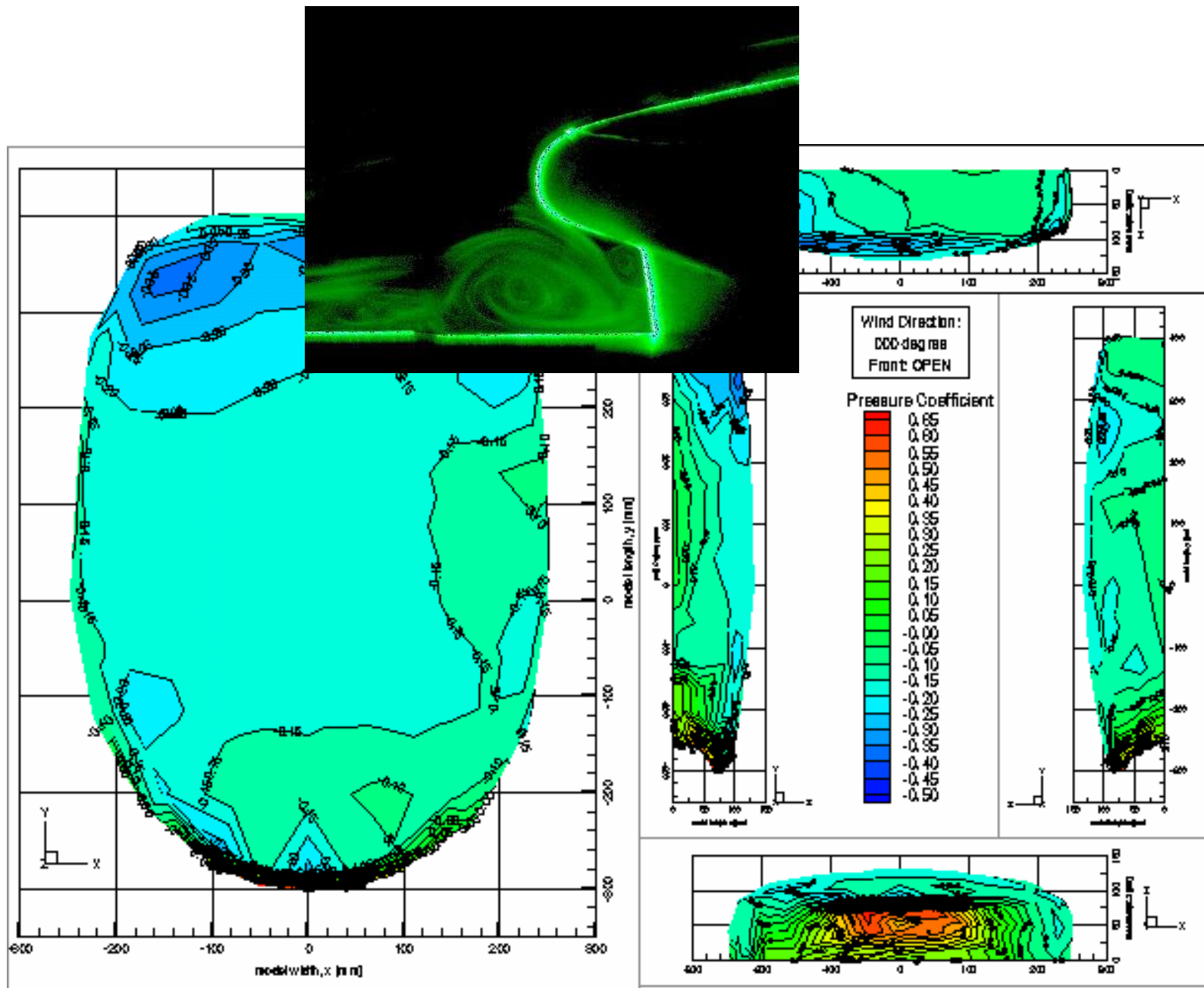

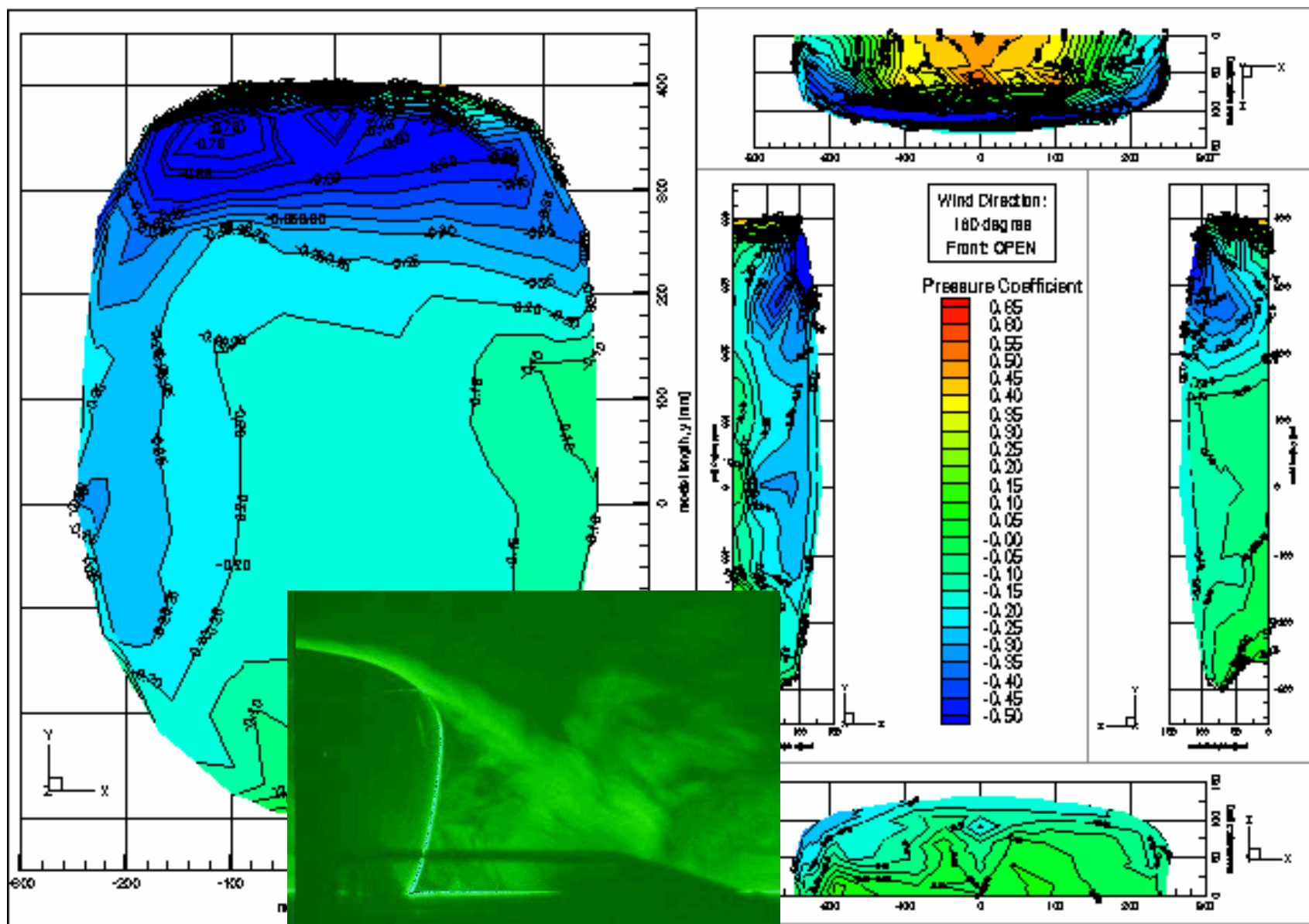

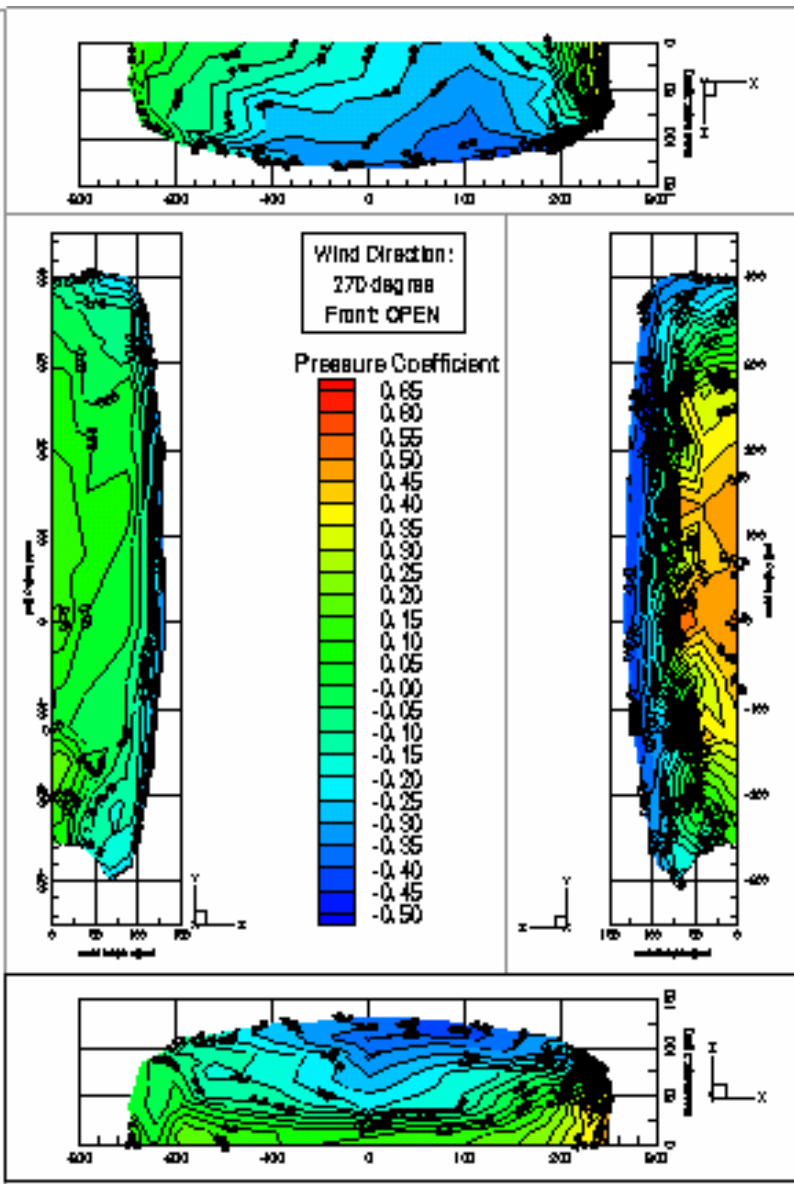
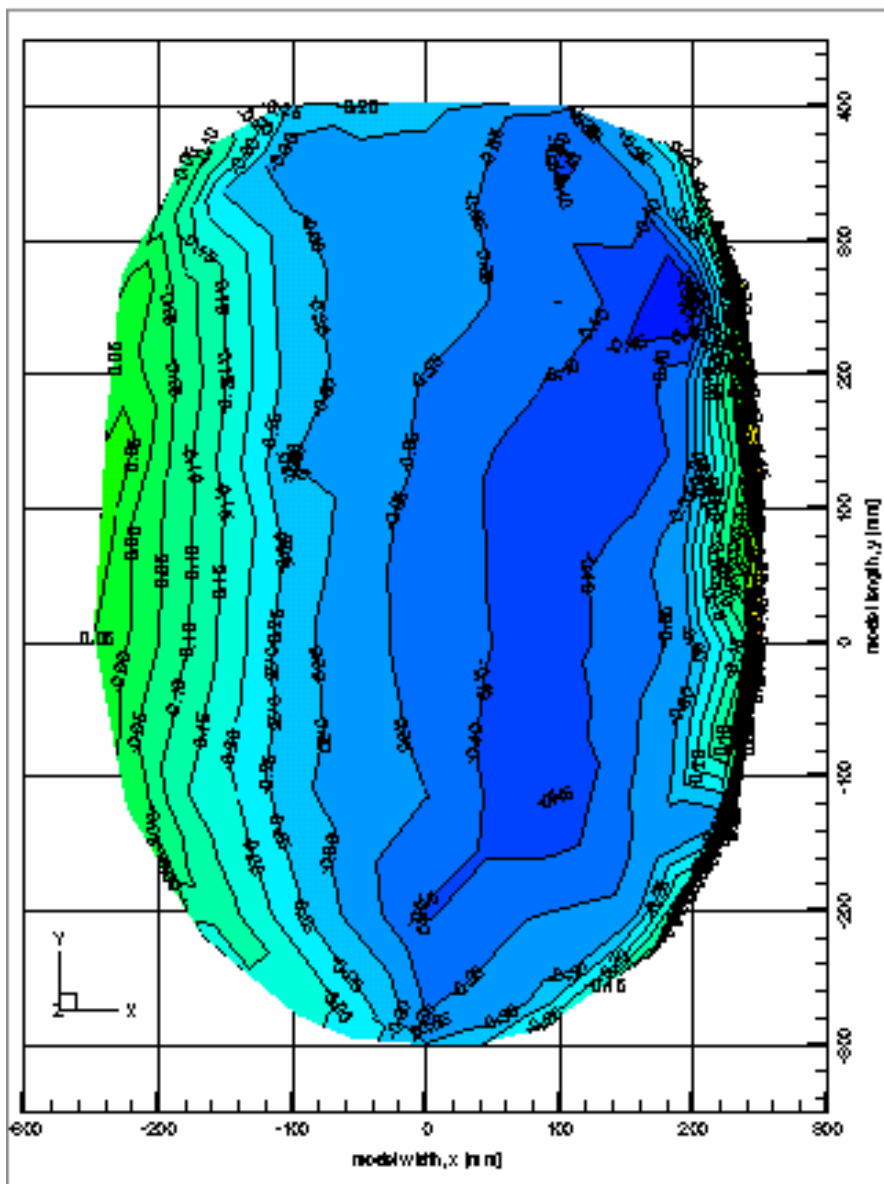

Ice-Stadium in Essen, Germany (Mertha Ing. Büro)

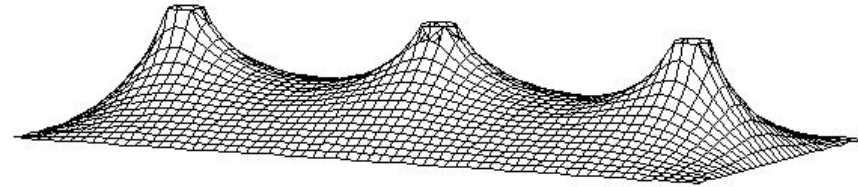

Calculated and measured pressure distributions

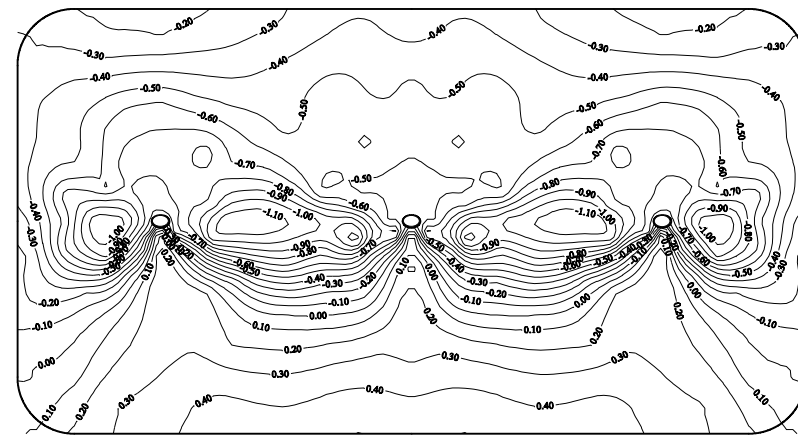

Bild 6. Druckbeiwerte an äußerer Oberfläche (Cpa [-])
Windrichtung 0° 1:300

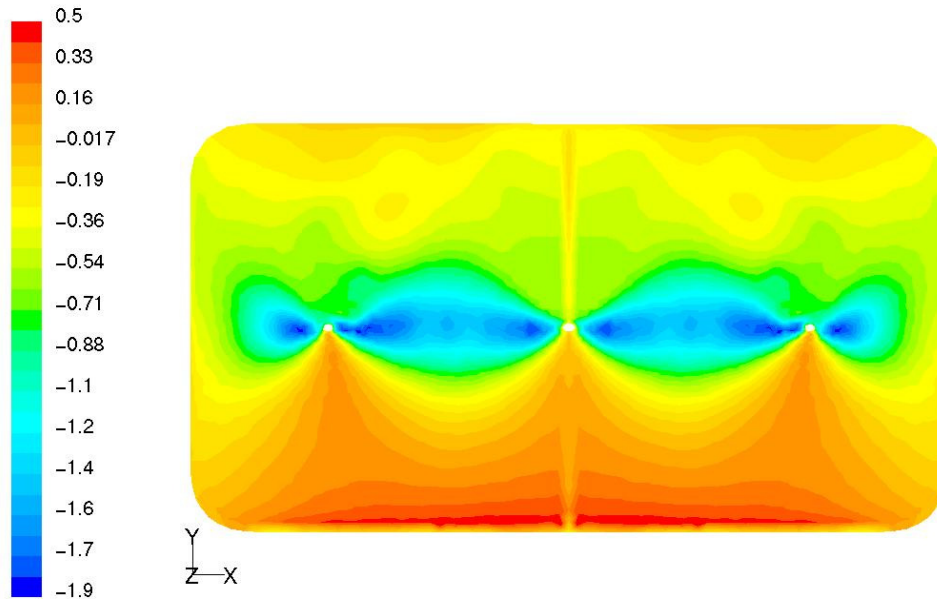

Contours of Pressure Coefficient

May 21, 2002
FLUENT 6.0 (3d, segregated, rke)